



INTERIOR COLLECTION



Interior Door Introduction and Design Ideas

Quick Ship Shaker Panel Doors Beading Configuration

Quick Ship Shaker Panel Doors and Bi-Folds

Quick Ship Shaker French Doors

Quick Ship Plantation Louver Doors and Bi-Folds

Quick Ship Rustic Barn Doors, Track Hardware & Accs

French Doors | Technical Information

French Door Collection

French Doors | Size Specification

Track Hardware & Accs

Shaker Doors | Size Specification



PRIVACY GUIDE

We offer an extensive line of glass options to choose from and the degree of opacity varies considerably . With each design , we have included a number which represents the “Privacy Level” for that product . Please refer to the guide below. **Note:** This guide is subjective. It should only be used when comparing our glass designs.

PRIVACY	1	2	3	4	5	6	7	8	9	10	
Completely Clear											
Objects can be clearly seen through the glass from the opposite side.											
Diffused/Distorted											
Objects are distorted, but can still be detected from the opposite side.											
Completely Opaque											
Only light will travel through from the opposite side.											

Please Note: We make every effort to ensure all Quick Ship Items are in stock. However, due to market demand we can not guarantee stock. Please contact your representative to confirm availability.

We offer a wide variety of Stile and Rail Panel, Barn and French doors that will complement any home design.

Our Quick Ship program includes an extensive selection of Shaker, French, Louver or Barn doors, ready for when you need them.

We help you create an interior look that reflects your unique taste. Now it's your time to choose.



Primed 8402 Shaker



COASTAL

The Coastal home style is relaxing, light, and breezy. Its open design and lighter tones mirror the natural beauty of the shoreline.

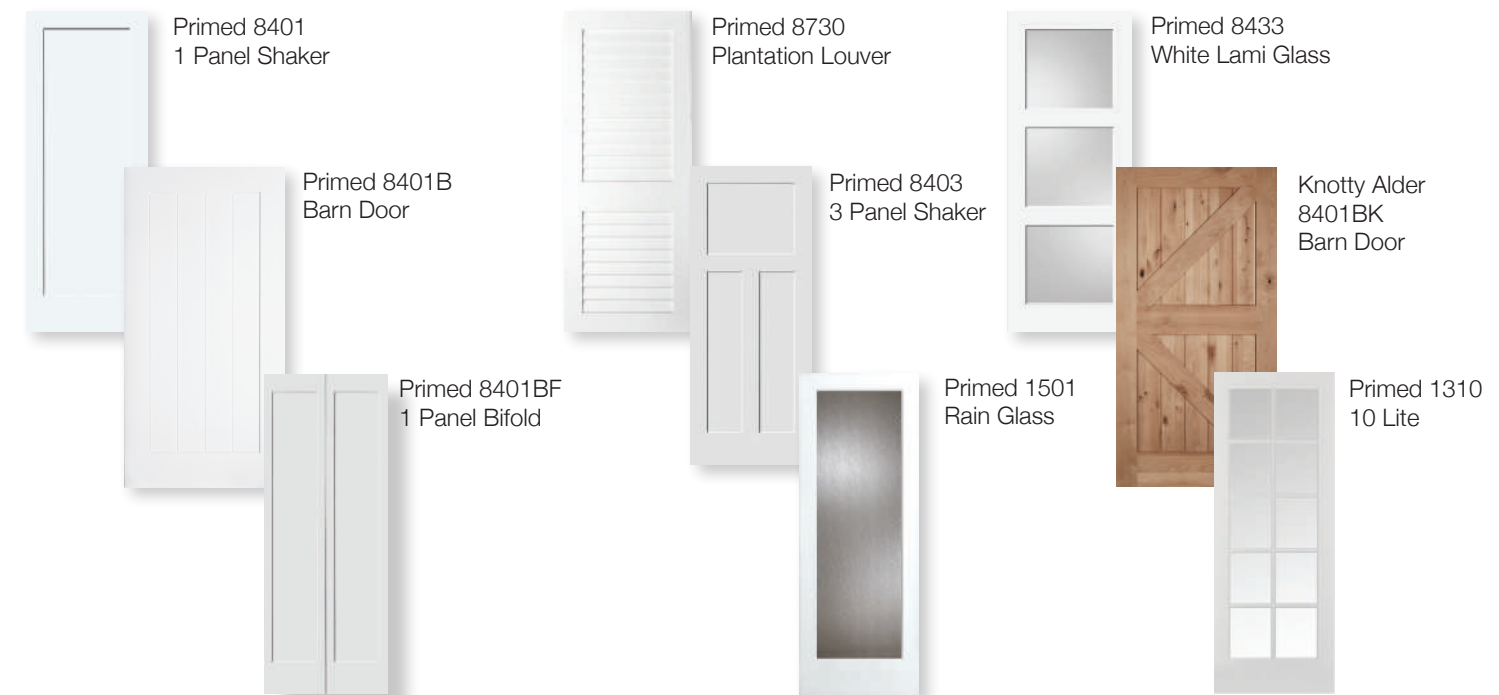



CONTEMPORARY

Contemporary homes reflect the architecture and design of today. They represent sharp design and clean curb appeal.



CRAFTSMAN

Craftsman homes emphasize hand-worked touches and beautiful detailing. Popularized at the turn of the 20th Century, it remains a popular design aesthetic.

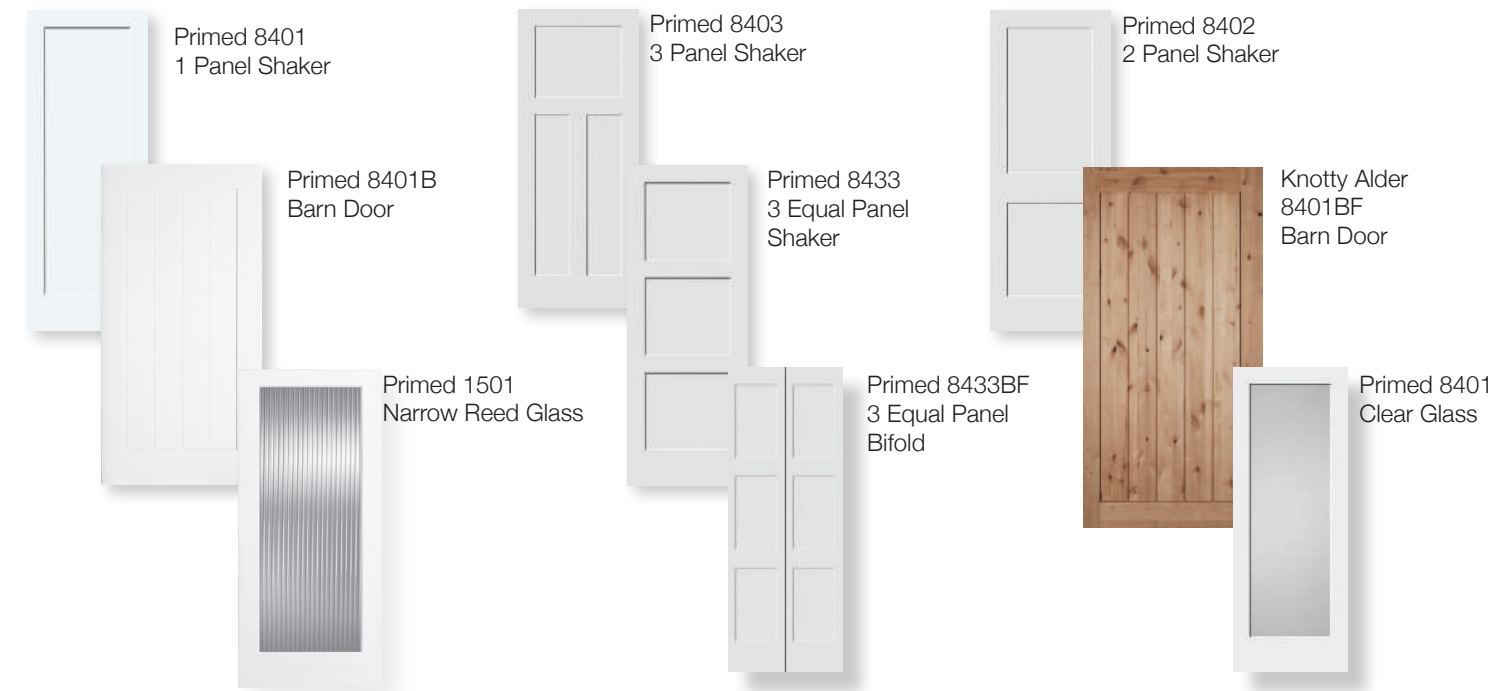
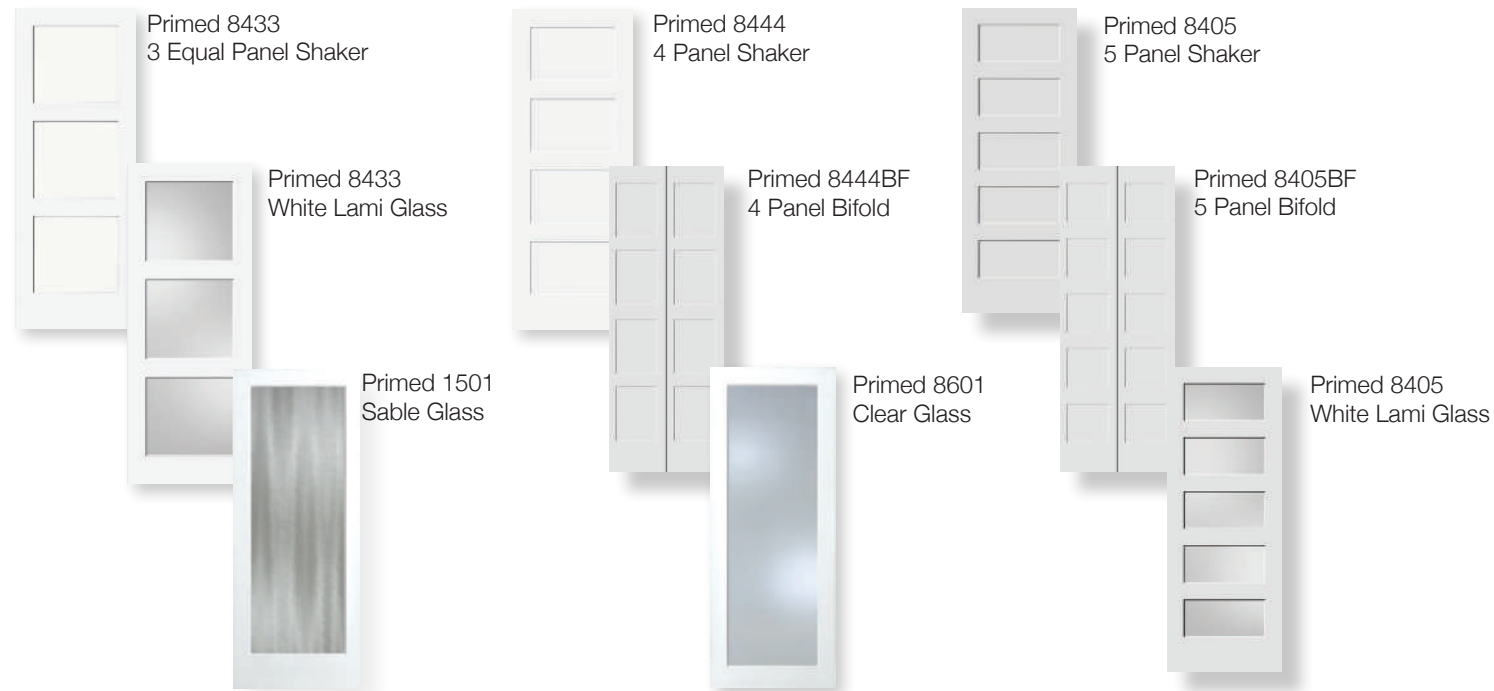





















CLASSIC

Classic homes are comforting and familiar. Their interiors are calm, orderly and consistent.



CARIBBEAN

The Caribbean design combines aspects of Mediterranean, Spanish, and many other tropical architectural styles. Rustic textures compliment vivid color schemes in an inspiring mix of old world charm and casual playfulness.

 <p>Primed OV22 2 Panel Shaker</p>	 <p>Primed 8730 Plantation Louver</p>	 <p>Primed 8402 2 Panel Shaker</p>	 <p>Primed 8401BZ Barn Door</p>	 <p>Knotty Alder 8401BF Barn Door</p>	 <p>Primed OV22 2 Panel Shaker</p>
 <p>Primed OV22BF 2 Panel Bifold</p>	 <p>Primed 8730BF Plantation Louver Bifold</p>	 <p>Primed 8402BF 2 Panel Bifold</p>	 <p>Primed 8730BF Plantation Louver Bifold</p>	 <p>Primed 1501 Sable Glass</p>	 <p>Primed 1501 Narrow Reed Glass</p>
 <p>Primed 1501 Pantry</p>	 <p>Primed 1501 Rain Glass</p>	 <p>Primed 1501 Laundry</p>	 <p>Primed 1501 Clear Glass</p>	 <p>Primed 8730 Plantation Louver</p>	 <p>Knotty Alder 8401BK Barn Door</p>

Get the beautiful interior doors you need at the right time, and cost with our Quick Ship* program. We stock a wide variety of designs and sizes to meet the varying needs and tastes in our market.

The largest offering in our program is our Shaker Door Collection. These stile and rail panel doors offer the look and feel of a high-end interior door at a cost effective price point.

**We make every effort to ensure all Quick Ship Items are in stock. However, due to market demand we can not guarantee stock. Please contact your representative to confirm availability.*

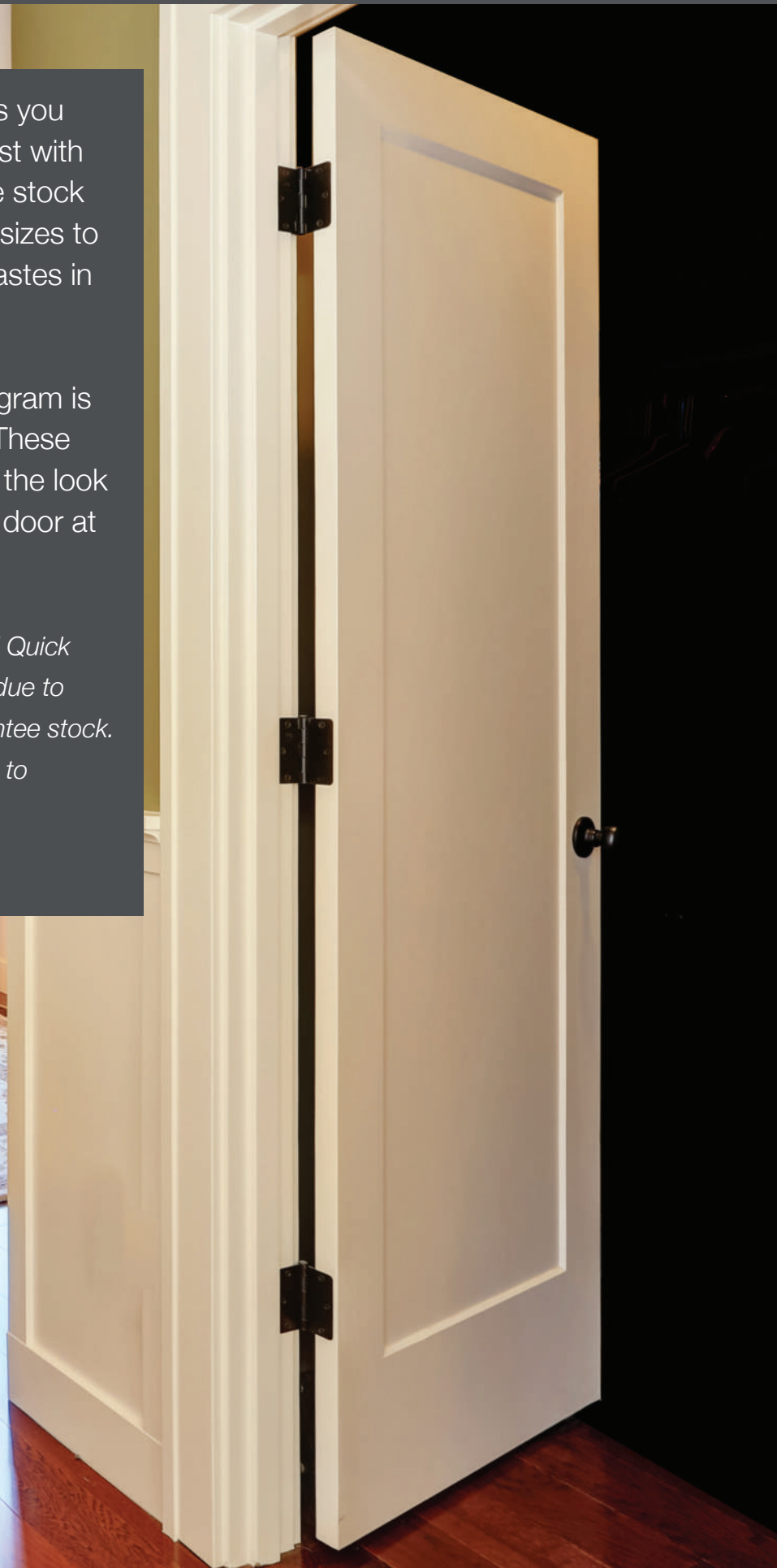

Primed 8401

Shaker Door Beading Configurations

Some of our Shaker Doors have different beading options which can give them a different appearance. While most of our designs come with the Standard Shaker Profile which has no beading, the OV22 design comes with Ovolo beading



Standard Shaker Profile



8401

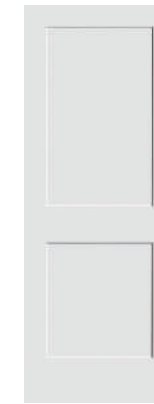

8402



8403

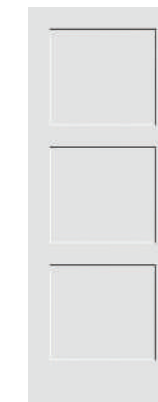

8433



8444



8405



Option Ovolo Bead



OV22

Shaker Panel Doors

6/8
1-3/8"



Shaker Panel Doors

6/8
1-3/4"



7/0
1-3/8"



7/0
1-3/4"



8/0
1-3/8"



8/0
1-3/4"



Shaker Bifolds (HARDWARE INCLUDED)

6/7
1-3/8"



Shaker French Doors: Diffused White Laminated (DWL) or Clear

6/8
1-3/8"



8401



8433



8405



Clear Safety Glass
PRIVACY 1



DWL Safety Glass
PRIVACY 10

8/0
1-3/8"



8401



8433



8405



8730 Louver

Primed Louver doors and bifolds increase ventilation and promote air flow between rooms.

Our 3-1/4" solid wood louver slats allow for increased privacy while maintaining all of the conventional benefits of a venting louver.



8405 Clear Glass Primed Shaker

Louver Door

6/8
1-3/8"



8730

Louver Bifolds

6/7
1-3/8"



8730BF

We offer a wide selection of Rustic and Shaker style barn doors in both standard and oversized widths. Our barn doors comes with a routed groove to complement our barn door track. Select yours today.

Rustic Barn Doors

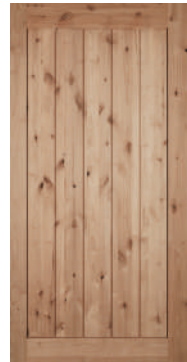

SKA8401B
Knotty Alder



SKA8401BZ
Knotty Alder



SKA8402BK
Knotty Alder



PRI8401B
Primed



PRI8401BZ
Primed



PRI8402BK
Primed

Shaker Panel Barn Doors

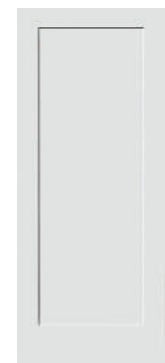

8401



8402



8433



8405

We offer several barn door and hardware options in matte black and brushed stainless steel. There are two styles of barn door track, rustic and contemporary. Our rustic track comes with a bent strap hanger. We also offer a contemporary track with a top mount roller. Our hardware is tested to handle doors up to 225 pounds and comes in two sizes, 84" and 96". Select your track and pair it with the perfect barn door handle and pull.

Rustic Track + Hardware



Matte Black



Brushed Stainless Steel

Contemporary Track + Hardware



Matte Black



Brushed Stainless Steel



3'6" x 7'0" Primed 8401BZ with Rustic Track.



3'0" x 7'0" Knotty Alder 8401BZ with Matte Black Hardware and 6-1/2" Handle

Contemporary Bar Pulls



Contemporary pull sizes 12" & 24" in both Stain Nickel & Matte Black. (Matches Stainless Steel Track)

Rectangular Flush Pulls



Matte Black 6 1/2"



Brushed Stainless Steel 6 1/2"

Rustic Handles



Matte Black 6 1/2"



Brushed Stainless Steel 6 1/2"

Soft Close Hardware



Matte Black

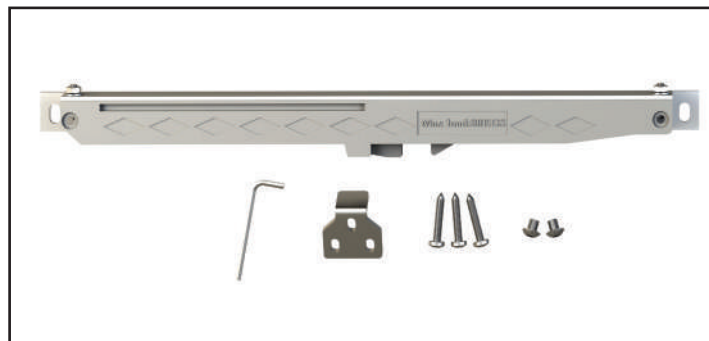

Matte Grey (Matches Stainless Steel Track)

Handle & Flush Pull Kits



Matte Black 12"

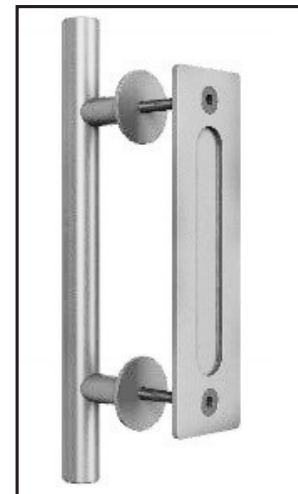

Brushed Stainless Steel 12"

Other parts and accessories are stocked in both Stainless Steel & Matte Black finishes, talk to your rep for more details.

French Doors

We offer a versatile selection of Primed French Door styles and glass designs to complement any architectural style.

There are two French Door styles available—the 1501, which has the traditional Ovolo French Door bead, or the 8601*, which comes with a contemporary Quirk bead. We offer a wide variety of clear or privacy glass options, sure to complement any decor.

Choose your door in 2 easy steps:

1. Choose Your Door Style
See options on page 20.



1501
Ovolo Bead



8601*
Quirk Bead

2. Choose Your Glass:
See options on page 21.



3'0" x 8'0" 1501 Primed French Door With Rooftop Glass

Traditional OVOLO #1501

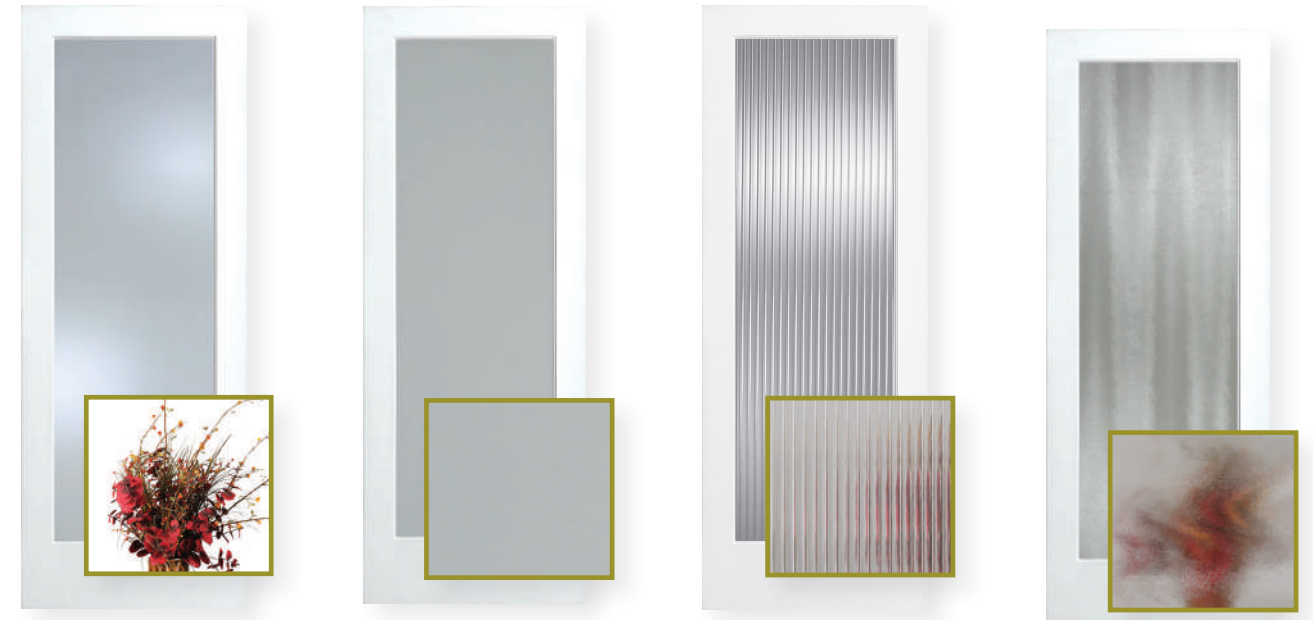
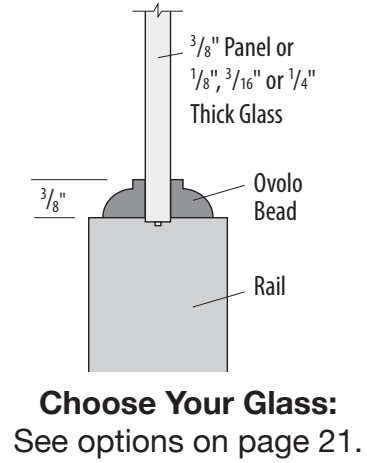
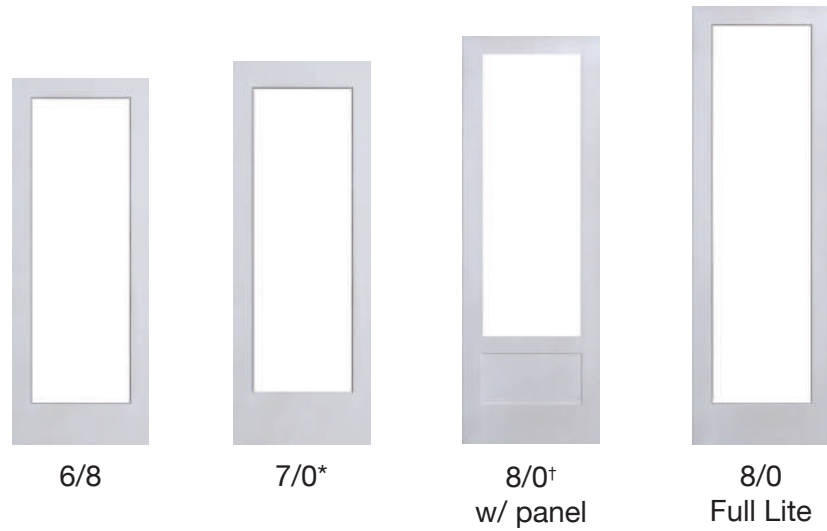

Clear † PRIVACY 1
Diffused White Laminate † PRIVACY 10
Narrow Reed † PRIVACY 8
Sable † PRIVACY 9

Modern QUIRK #8601

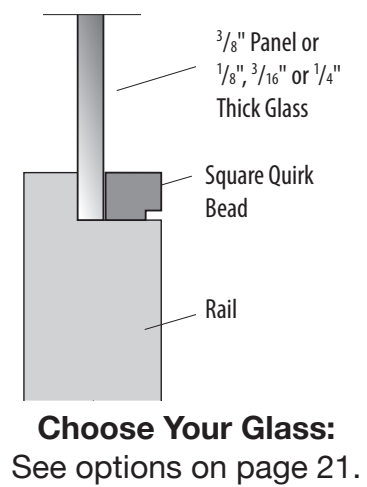
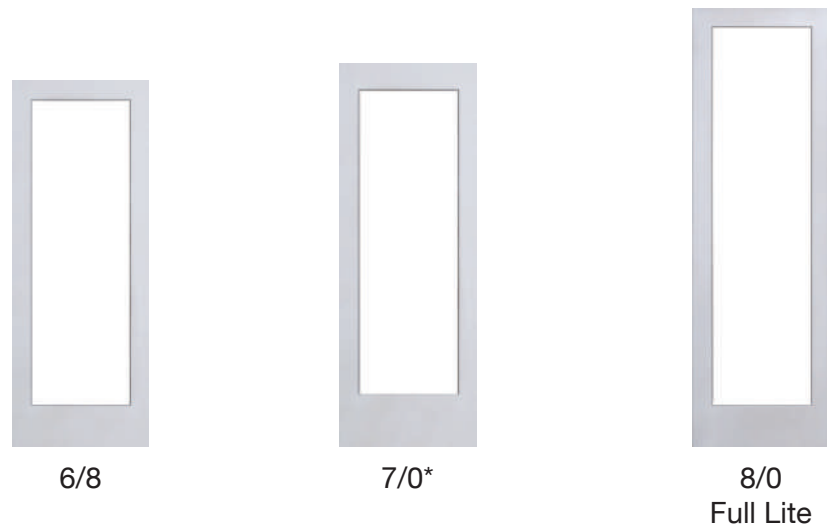

Rain † PRIVACY 9
Pantry † PRIVACY 8
Laundry † PRIVACY 8
10 Lite † φ PRIVACY 1

† Actual size not shown
*7/0 doors may have larger top and bottom rail.

† Tempered Safety Glass
‡ Laminated Safety Glass
φ Ovolo Bead Only

Note: Also available in 7/0 & 8/0*
See chart on page 22 for availability

Please refer to the following guide to confirm what sizes are available in our different product choices.

Page 21 Full Lite French Door Glass Designs	Door Widths (1501 & 8601 Model)									
6/8 Height 1-3/8" Thick	1/6	1/8	1/10	2/0	2/2	2/4	2/6	2/8	2/10	3/0
Clear	▪			▪	▪	▪	▪	▪	▪	▪
Diffused White Laminate	▪			▪	▪	▪	▪	▪	▪	▪
Narrow Reed	▪			▪	▪	▪	▪	▪	▪	▪
Sable	▪			▪	▪	▪	▪	▪	▪	▪
Rain	▪			▪	▪	▪	▪	▪	▪	▪
Pantry				▪	▪	▪	▪	▪	▪	▪
Laundry							▪	▪	▪	▪
10 Lite				▪		▪	▪	▪		▪
7/0 Height 1-3/8" Thick	1/6	1/8	1/10	2/0	2/2	2/4	2/6	2/8	2/10	3/0
Clear				▪		▪	▪	▪		▪
Diffused White Laminate				▪		▪	▪	▪		▪
Narrow Reed				▪		▪	▪	▪		▪
Sable				▪		▪	▪	▪		▪
Rain				▪		▪	▪	▪		▪
Pantry				▪		▪	▪	▪		▪
8/0 Height 1-3/8" Thick	1/6	1/8	1/10	2/0	2/2	2/4	2/6	2/8	2/10	3/0
Clear				▪		▪	▪	▪		▪
Diffused White Laminate				▪		▪	▪	▪		▪
Narrow Reed				▪		▪	▪	▪		▪
Sable				▪		▪	▪	▪		▪
Rain				▪		▪	▪	▪		▪
Pantry				▪		▪	▪	▪		▪
Page 21 3/4 Lite Over 1 Panel French Door Glass Designs	Door Widths (1501 Model Only)									
8/0 Height 1-3/8" Thick	1/6	1/8	1/10	2/0	2/2	2/4	2/6	2/8	2/10	3/0
Clear				▪		▪	▪	▪		▪
Diffused White Laminate				▪		▪	▪	▪		▪
Narrow Reed				▪		▪	▪	▪		▪
Sable				▪		▪	▪	▪		▪
Rain				▪		▪	▪	▪		▪
Pantry				▪		▪	▪	▪		▪
Laundry							▪	▪		▪

The task of choosing the right interior door is only complete once you've chosen the right hardware and components to accompany it.

We are committed to providing you best-in-class products to hang, operate, and secure your interior door- all in a wide variety of styles and finishes to meet your specific design aesthetic.



Primed 8433 Shaker

3-1/2", 5/8" Radius Hinge Colors

4", 5/8" Radius Hinge Colors



Satin Nickel



Black



Oil Rubbed Bronze



Satin Nickel



Black



Oil Rubbed Bronze

All 20-Minute doors come with 2-spring hinges (not shown)

Flush Bolts

7" Flush Bolts
(Standard on 6-8 & 7-0 Doors)



Satin Nickel
(Also Available in Oil Rubbed Bronze)

18" Flush Bolts
(Standard on 8-0 Doors)



Oil Rubbed Bronze
(Also Available in Satin Nickel)

Ball Catch & Strike

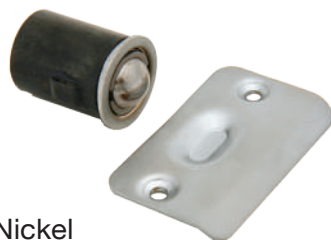

Satin Nickel
(Also Available in Black & Oil-Rubbed Bronze)

Bifold Rollers & Track



Heavy-duty aluminum box track and four-wheeled ball bearing rollers hold doors weighing up to 150 lbs. each.

Bypass Rollers & Track



Heavy-duty aluminum box track and two-wheeled ball bearing rollers hold doors weighing up to 150 lbs. each.

Roller Catch & Strike



Satin Nickel
(Also Available in Black & Oil-Rubbed Bronze)

Jams & Astragals



Primed Finger-Joint
Combo Jamb (4-9/16", 6-9/16" & 7-1/4")



Primed Finger-Joint Astragal

Sill Options

QOSR

- Thermal Efficient Composite Cap
- Durable Economic Design
- Water-Tight Butyl End Seal Gasket

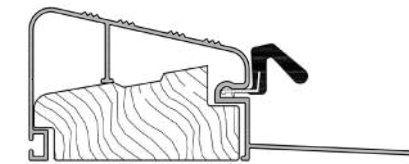

QOSH

- High Performance Seal Technology
- All Composite for Durability
- Adjustable Rail Ensuring a Tight Fit
- Water-Tight Butyl End Seal Gasket

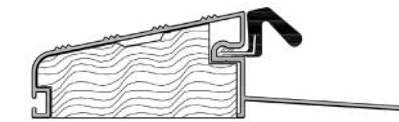

ISCS

- All-Aluminum Durability
- High Performance Inswing Design
- Water-Tight Butyl End Seal Gasket

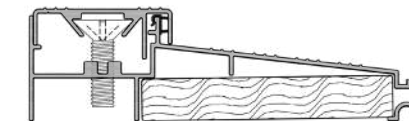

QOSO

- Stain Grade Oak Interior
- High Performance Outswing Design
- Water-Tight Butyl End Seal Gasket



ISW

- All-Aluminum Durability
- High Performance Inswing Design
- Water-Tight Butyl End Seal Gasket

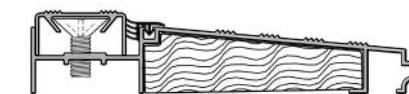

Sill Finishes



Mill Finish

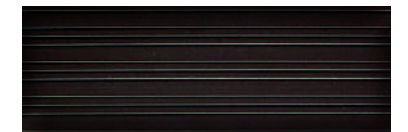

Black Finish



Bronze Finish

Jamb



Primed Single Rabbet Jamb
(4-9/16", 5-1/4" 6-9/16", 7-1/4")

QUICK SHIP STOCKING SIZES

LEGEND
■ = IN STOCK ■ = IN STOCK 20 MIN FIRE RATED

Page 10 Primed Shaker Doors & Bi-Folds	Door Widths										Bi-Fold Widths (6/7 Height)		
6/8 Height 1-3/8" Thick	1/6	1/8	1/10	2/0	2/2	2/4	2/6	2/8	2/10	3/0	2/0	2/6	3/0
8401	■	■	■	■	■	■	■	■	■	■	■	■	■
8402	■	■	■	■	■	■	■	■	■	■	■	■	■
8403	■	■	■	■	■	■	■	■	■	■	■	■	■
8433	■	■	■	■	■	■	■	■	■	■	■	■	■
8444	■	■	■	■	■	■	■	■	■	■	■	■	■
8405	■	■	■	■	■	■	■	■	■	■	■	■	■
OV22	■	■	■	■	■	■	■	■	■	■	■	■	■
7/0 Height 1-3/8" Thick	1/6	1/8	1/10	2/0	2/2	2/4	2/6	2/8	2/10	3/0	2/0	2/6	3/0
8401				■	■	■	■	■	■	■			
8402				■	■	■	■	■	■	■			
8403				■	■	■	■	■	■	■			
8433				■	■	■	■	■	■	■			
8405				■	■	■	■	■	■	■			
8/0 Height 1-3/8" Thick	1/6	1/8	1/10	2/0	2/2	2/4	2/6	2/8	2/10	3/0	2/0	2/6	3/0
8401	■			■	■	■	■	■	■	■			
8402	■			■	■	■	■	■	■	■			
8403	■			■	■	■	■	■	■	■			
8433	■			■	■	■	■	■	■	■			
8405	■			■	■	■	■	■	■	■			
OV22	■			■	■	■	■	■	■	■			
Page 11 Primed Shaker Doors & Bi-Folds	Door Widths										Bi-Fold Widths (6/7 Height)		
6/8 Height 1-3/4" Thick	1/6	1/8	1/10	2/0	2/2	2/4	2/6	2/8	2/10	3/0	2/0	2/6	3/0
8401				■	■	■	■	■	■	■			
8402				■	■	■	■	■	■	■			
8403				■	■	■	■	■	■	■			
8433				■	■	■	■	■	■	■			
8444							■	■		■			
8405				■	■	■	■	■	■	■			
7/0 Height 1-3/4" Thick	1/6	1/8	1/10	2/0	2/2	2/4	2/6	2/8	2/10	3/0	2/0	2/6	3/0
8401								■	■	■			
8402								■	■	■			
8403								■	■	■			
8433								■	■	■			
8405								■	■	■			

LEGEND
■ = IN STOCK ■ = IN STOCK 20 MIN FIRE RATED

Page 11 Primed Shaker Doors & Bi-Folds	Door Widths										Bi-Fold Widths (6/7 Height)		
8/0 Height 1-3/4" Thick	1/6	1/8	1/10	2/0	2/2	2/4	2/6	2/8	2/10	3/0	2/0	2/6	3/0
8401				■	■	■	■	■	■	■			
8402				■	■	■	■	■	■	■			
8403							■	■	■	■			
8433				■	■	■	■	■	■	■			
8405				■	■	■	■	■	■	■			
Page 12 Primed Shaker French Doors	Door Widths										Glass Type		
6/8 Height 1-3/8" Thick	1/6	1/8	1/10	2/0	2/2	2/4	2/6	2/8	2/10	3/0	Clear	Diffused White	
8401	■			■	■	■	■	■	■	■	■	■	
8433	■			■	■	■	■	■	■	■	■	■	
8405	■			■	■	■	■	■	■	■	■	■	
8/0 Height 1-3/8" Thick	1/6	1/8	1/10	2/0	2/2	2/4	2/6	2/8	2/10	3/0	Clear	Diffused White	
8401	■			■	■	■	■	■	■	■	■	■	
8433	■			■	■	■	■	■	■	■	■	■	
8405	■			■	■	■	■	■	■	■	■	■	
Page 13 Plantation Louvers & Bi-Folds	Door Widths										Bi-Fold Widths (6/7 Height)		
6/8 Height 1-3/8" Thick	1/6	1/8	1/10	2/0	2/2	2/4	2/6	2/8	2/10	3/0	2/0	2/6	3/0
8730	■			■	■	■	■	■	■	■	■	■	■
7/0 Height 1-3/8" Thick	1/6	1/8	1/10	2/0	2/2	2/4	2/6	2/8	2/10	3/0	2/0	2/6	3/0
8730				■		■	■	■	■	■			
8/0 Height 1-3/8" Thick	1/6	1/8	1/10	2/0	2/2	2/4	2/6	2/8	2/10	3/0	2/0	2/6	3/0
8730	■			■	■	■	■	■	■	■			
Page 16 Barn Doors	Door Widths												
7/0-8/0 Height 1-3/8" Thick	3'0"x 7'0"	3'6"x 7'0"	4'0"x 7'0"	3'6"x 8'0"									
SKA8401B Knotty Alder	■	■	■										
SKA8401BZ Knotty Alder	■	■	■	■									
SKA8402BK Knotty Alder	■	■	■										
PRI8401B Primed	■	■	■										
PRI8401BZ Primed	■	■	■	■									
PRI8401BK Primed	■	■	■										

Any Shaker door can be prepped for use as a barn door.

