



DOOR SLABS, COMPONENTS & HARDWARE



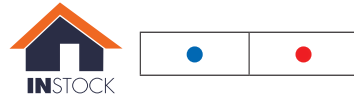

Table of contents

All products featured are stocked in our Tampa warehouse. Many items in this catalog have reduced pricing if purchased in full pack quantities (full pallet/box/roll); however, some smaller commodity items can only be purchased in those full pack quantities. There are also a select few items that can be purchased in less than full pack quantities if a \$5.00 broken pack handling charge is applied to the order's footer.

If an item must be purchased at full pack quantities, or will incur a broken pack handling charge, then that item's chart in the catalog will have a column at the far right called "MIN QTY".

If an item can be purchased at broken pack quantities, but there is a discount for full pack quantities, then that item's chart will have a column at the far right called "QTY BRK".

If an item's chart does not have a column with either of those labels, then that item can be purchased at broken pack quantities, and it has no full pack quantity discount.

Consult your Slabs, Components, and Hardware Net Price Sheets for more details on what the discounts are, and exactly which items will get the \$5.00 charge if purchased in broken pack quantities.

On door slab pages, red bullets represent panels for use in the HVHZ (High Velocity Hurricane Zone) and blue bullets represent panels for use in the WBD (Wind Borne Debris) Zones.

IMPACT FIBERGLASS SLABS & SASHES	3-14
IMPACT DIRECT-GLAZED SLABS	15
NON-IMPACT DIRECT-GLAZED SLABS	16
SPECIFICATIONS (GLASS SIZE OPTIONS BY DOOR PANEL)	17-22
PET DOOR INSERTS	23-24
VENTILATING DOORGLASS	25
DOOR LOUVERS	26
ADHESIVE SDL BARS	27
FRAMES & MOULDINGS	28-30
PAINT & STAIN KITS	31
ALUMINUM ASTRAGALS	32-36
ALUMINUM THRESHOLDS	37-44
WEATHER SEALS	45-48
DOOR HINGES	49-52
MULTI-POINT SECURITY HARDWARE	53-57
SECURITY HARDWARE	58-65
COMMERCIAL HARDWARE	66
HOUSE NUMBERS	67-68
EXTERIOR DOOR ACCESSORIES	69
DOOR STOPS	70-72
BARN DOOR HARDWARE	73
FLIP LEVER FLUSH BOLTS	74
GENERAL HARDWARE	75-81
SHIPPING & INSTALLATION PRODUCTS	82

Exterior Door Code Compliance

	= HVHZ IMPACT		= STRUCTURAL
	= Florida Wind-Borne Debris (WBD) IMPACT		= STRUCTURAL

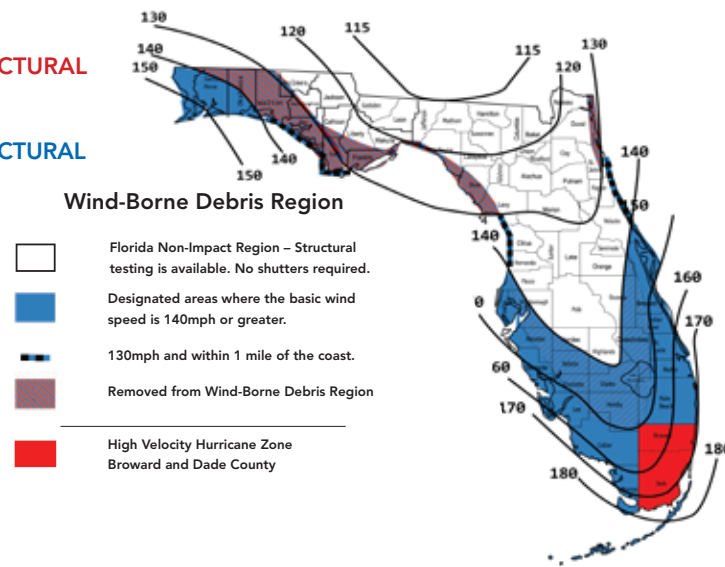

All door panels shown in this catalog (listed as HVHZ or WBD) will meet local and state product approval requirements when:

- Used with the correct components
- Assembled by a qualified door shop that has third party quality assurance certification
- Used in compliance with actual Plastpro Florida product approvals (See floridabuilding.org).

Exterior Door Energy Compliance

All door panels as shown meet the Florida State Minimum Energy Code. For these doors to qualify in a system, components that meet the energy standard must be used, and should be labeled by a certified shop with NFRC labels.

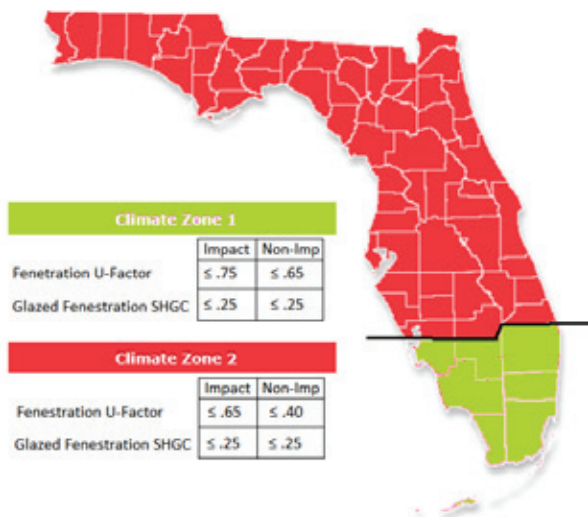

All products featured are stock items. Stock items subject to change.

IMPACT FIBERGLASS SLABS

IMPACT FIBERGLASS SLABS & SASHES

These doors combine sleek contemporary design with technologically advanced construction.

All door panels are sold unfinished.

Cut Out Specifications can be found on Pages 17-22

 FIRE RATED DOORS CAN BE SPECIAL ORDERED, MINIMUM PALLET QUANTITY REQUIRED.



MODERN & SHAKER COLLECTION

DOOR NAME	ITEM#	HEIGHT	QTY BRK	2/8	3/0
Modern Milan Teak Grain	DMT51	6/8	25		●
1 Panel Shaker Smooth	DRS1K	6/8	25		●
2 Panels Shaker Smooth	DRS2K	6/8	25		●
3 Panels Shaker Smooth	DRS3F	6/8	25	●	●
3 Panels Shaker Fir Grain	DRF3F	6/8	25		●
5 Panels Shaker Smooth	DRS50	6/8	25		●
3 Panels Shaker Smooth	DRS3F80	8/0	22		●
3 Panels Shaker Fir Grain	DRF3F80	8/0	22		●



NEW!

Modern Milan 6/8 (TEAK GRAIN)



1 Panel Shaker 6/8



2 Panels Shaker 6/8



3 Panels Shaker 6/8



3 Panels Shaker 6/8 (FIR GRAIN)



5 Panels Shaker 6/8



3 Panels Shaker 8/0



3 Panels Shaker 8/0 (FIR GRAIN)



Distinct European architectural style. When stained, deep wood graining and plank details resemble the true look of a distressed wood door.

All door panels are sold unfinished.

Cut Out Specifications can be found on Pages 17-22

 FIRE RATED DOORS CAN BE SPECIAL ORDERED, MINIMUM PALLET QUANTITY REQUIRED.



RUSTIC SERIES

DOOR NAME	ITEM#	HEIGHT	QTY BRK	1/0	1/2	3/0	3/0
2 Panels Plank Arch Panel	DRA2A	6/8	5			●	●
2 Panels	DRA2B	6/8	5				●
2 Panels Arch	DRA2D	6/8	5				●
Blank Top 1 Panel Sidelite	SLA2B	6/8	5	●			
2 Panels Plank Arch Panel	DRA2A80	8/0	5			●	●
2 Panels Plank	DRA2P80	8/0	5			●	
Full Lite Sidelite 9x81 Cut Out for 8x80 Insert	SLM608010CO	8/0	5	●			



PLASCLVSS1/2 SQUARE CLAVOS 1.50"



PLASCLVSS1/4 SQUARE CLAVOS 1.25"



PLASCLVSR1/2 ROUND CLAVOS 1.50"



PLASCLVSR1/4 ROUND CLAVOS 1.25"



2 Panels Plank Arch Panel 6/8



2 Panels 6/8



2 Panels Arched Panel 6/8



Blank Top 1 Panel



2 Panels Plank Arch Panel 8/0



2 Panels Plank 8/0



Full Lite 8/0



Woodgrain doors have a stainable rich oak grain pattern that resembles the look, feel, and texture of real wood without any of the problems associated with it.

*All door panels are sold unfinished.
Natural color of wood grain textured is tan.

Cut Out Specifications can be found on Pages 17-22

FIRE RATED DOORS CAN BE SPECIAL ORDERED, MINIMUM PALLET QUANTITY REQUIRED.

6/8 DOOR CROSS SECTION

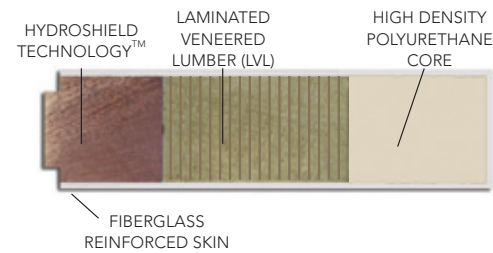

TAN WOODGRAIN 6/8

DOOR NAME	ITEM#	WBD IMPACT						FVHZ IMPACT							
		1/0	1/2	2/0	2/4	2/6	2/8	2/10	3/0	1/0	1/2	2/6	2/8	2/10	3/0
Flush	DRG00			●		●	●	●	●			●	●		●
Full Lite 23x65 Cut Out for 22x64 Insert	DRG00CO						●		●						
Full Lite 21x65 Cut Out for 20x64 Insert	DRG00CO					●									
3/4 2 Panels	DRG29								●						
3/4 Premium	DRG3P								●						
Blank Top 4 Panels	DRG40						●		●						●
1/2 Lite Over 2 Panels 23x37 Cut Out for 22x36 Insert	DRG40CO								●						
3/4 4 Panels	DRG49						●		●						
6 Panels	DRG60					●			●						●
6 Panels Utility	DRG61												●		
6 Panels Narrow	DRG63							●							
Flush Sidelite	SLG00	●	●							●	●				
Full Lite Sidelite 8x65 Cut Out	SLG00CO	●	●												
3/4 Lite Over 1 Panel Sidelite 9x49 Cut Out for 8x48 Insert	SLG49CO	●													

Purchase 25 each of any specific 6/8 Door Slab to receive a Quantity Break Discount. Purchase 30 each of any specific 6/8 Sidelite Sash to receive a Quantity Break Discount.



Flush 6/8



3/4 2 Panels 6/8



3/4 Premium 6/8



Blank Top 4 Panels 6/8



3/4 4 Panels 6/8



6 Panels 6/8



6 Panels Utility 6/8



Flush Sidelite 6/8



Full Lite 6/8

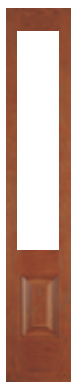

3/4 Lite Over 1 Panel 6/8

See Specifications Page 19 for important information about cut-out sizes on the DRG60, DRG61, and DRG63)

IMPACT FIBERGLASS SLABS & SASHES

IMPACT FIBERGLASS SLABS & SASHES



Woodgrain doors have a stainable rich oak grain pattern that resembles the look, feel, and texture of real wood without any of the problems associated with it.

*All door panels are sold unfinished.
Natural color of wood grain textured is tan.

Cut Out Specifications can be found on Pages 17-22

FIRE RATED DOORS CAN BE SPECIAL ORDERED, MINIMUM PALLET QUANTITY REQUIRED.

8/0 DOOR CROSS SECTION

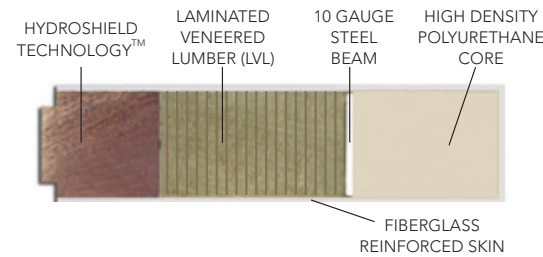

TAN WOODGRAIN 8/0

DOOR NAME	ITEM#	WBD IMPACT			HVHZ IMPACT			
		1/0	1/2	2/8	3/0	1/0	1/2	3/0
Flush	DRG0080			●	●			●
Full Lite 23x81 Cut Out for 22x80 Insert	DRG0080CO			●	●			
3/4 2 Panels	DRG2980			●	●			
3/4 3 Panels	DRG3080				●			
True 4 Panels	DRG4180				●			
6 Panels	DRG6080			●	●			
Flush Sidelite	SLG0080	●	●			●	●	
Full Lite Sidelite 9x81 Cut Out for 8x80 Insert	SLG0080CO	●	●					
3/4 Lite Over 1 Panel 8x65 Cut Out for 7x64 Insert	SLG3080CO	●						

Purchase 22 each of any specific 8/0 Door Slab or 8/0 Sidelite Sash to receive a Quantity Break Discount.



Flush 8/0



3/4 2 Panels 8/0



3/4 3 Panels 8/0



True 4 Panels 8/0



6 Panels 8/0



Flush Sidelite



Full Lite



3/4 Lite Over 1 Panel

See Specifications Page 21 for important information about cut-out sizes on the DRG6080



These doors are scratch-resistant! Patented, pre-pigmented skin infuses the door white through and through. Can be painted or faux finished to coordinate with your home decor.

All door panels are sold unfinished.
Natural color of smooth is white.



Cut Out Specifications can be found on Pages 17-22

 INDICATES STOCKED 20 MINUTE FIRE RATED DOORS. OTHER FIRE RATED DOORS CAN BE SPECIAL ORDERED, MINIMUM PALLET QUANTITY REQUIRED.

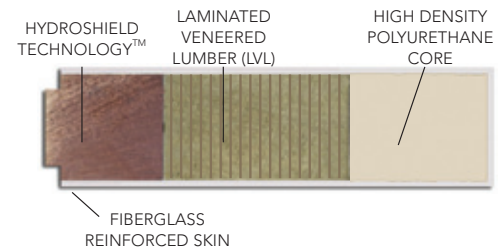
6/8 DOOR CROSS SECTION



WHITE SMOOTH 6/8

DOOR NAME	ITEM#	WBD IMPACT						HVHZ IMPACT					
		2/0	2/4	2/6	2/8	2/10	3/0	2/0	2/4	2/6	2/8	2/10	3/0
Flush	DRS00	●	●	●	●	●	●	●	●	●	●	●	●
Full Lite 23x65 Cut Out for 22x64 Insert	DRS00CO				●	●	●						●
Full Lite 21x65 Cut Out for 20x64 Insert	DRS00CO			●									
Narrow Full Lite 15x65 Cut Out for 14x64 Insert	DRS00CO	●											
Flush Undersize 78"	DRS0021078					●							
Full Lite Undersize 78" 23x65 Cut Out for 22x64 Insert	DRS0021078CO					●							
3/4 2 Panels	DRS29				●		●						●
2 Panels	DRS2B				●		●				●		●
2 Panels Arch Panel	DRS2D				●		●						●
2 Panels Plank Arch Panel	DRS2G				●		●						●
3 Panels Elite	DRS3E						●						
3 Panels Premium	DRS3P						●						
6 Panels	DRS60			●			●			●			●
6 Panels Utility	DRS61						●					●	●
6 Panels Narrow	DRS63					●							
6 Panels 20m Fire Rated Double Bore & Hinge Prep	DRS602						●						
6 Panels Utility 20m Fire Rated Double Bore & Hinge Prep	DRS612				●								

WHITE SMOOTH 7/0

DOOR NAME	ITEM#	3/0
Flush	DRS0070	●

Purchase 25 each of any specific 6/8 or 7/0 Door Slab to receive a Quantity Break Discount.



Flush 6/8



3/4 2 Panels 6/8



2 Panels 6/8



2 Panels Arch Panel 6/8



2 Panels Plank Arch Panel 6/8



2 Panels Elite 6/8



3 Panels Premium



6 Panels 6/8

See Specifications Page 19 for important information about cut-out sizes on the DRS60, DRS61, and DRS63



These doors are scratch-resistant! Patented, pre-pigmented skin infuses the door white through and through. Can be painted or faux finished to coordinate with your home decor.

All door panels are sold unfinished.
Natural color of smooth is white.

Cut Out Specifications can be found on Pages 17-22

FIRE RATED DOORS CAN BE SPECIAL ORDERED, MINIMUM PALLET QUANTITY REQUIRED.

6/8 DOOR CROSS SECTION

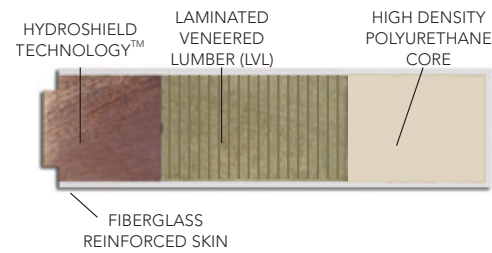

WHITE SMOOTH 6/8

DOOR NAME	ITEM#	WBD IMPACT					FMVHZ IMPACT				
		1/0	1/2	2/8	2/10	3/0	1/0	1/2	2/8	2/10	3/0
4 Panels Blank Top	DRS40			●	●	●			●	●	●
Half Lite Over 2 Panels 23x37 Cut Out for 22x36 Insert	DRS40CO			●		●					
True 4 Panels	DRS41					●			●	●	
3/4 4 Panels	DRS49			●		●					
8 Panels Center Arch	DRS80					●					
9 Panels	DRS90					●					
Flush Sidelite	SLS00	●	●				●	●			
Full Lite Sidelite 8x65 Cut Out for 7x64 Insert	SLS00	●	●								
3/4 Lite Over 1 Panel 9x49 Cut Out for 8x48 Insert	SLS49	●									
1/2 Lite Over 1 Panel 9x37 Cut Out for 8x36 Insert	SLS60	●									

Purchase 25 each of any specific 6/8 Door Slab to receive a Quantity Break Discount. Purchase 30 each of any specific 6/8 Sidelite Sash to receive a Quantity Break Discount.



Blank Top 4 Panels 6/8



True 4 Panels 6/8



3/4 4 Panels 6/8



8 Panels Center Arch 6/8



9 Panels 6/8



Flush Sidelite



Full Lite



3/4 Lite Over 1 Panel



1/2 Lite Over 1 Panel

IMPACT FIBERGLASS SLABS & SASHES

IMPACT FIBERGLASS SLABS & SASHES



These doors are scratch-resistant! Patented, pre-pigmented skin infuses the door white through and through. Can be painted or faux finished to coordinate with your home decor. All door panels are sold unfinished. Natural color of smooth is white.

Cut Out Specifications can be found on Pages 17-22

FIRE RATED DOORS CAN BE SPECIAL ORDERED, MINIMUM PALLET QUANTITY REQUIRED.

8/0 DOOR CROSS SECTION

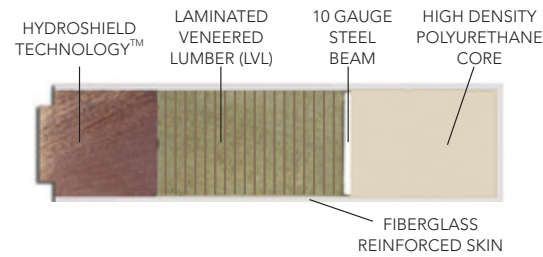

WHITE SMOOTH 8/0

DOOR NAME	ITEM#	WBD IMPACT						HVHZ IMPACT							
		1/0	1/2	2/0	2/4	2/6	2/8	2/10	3/0	1/0	1/2	2/6	2/8	2/10	3/0
Flush	DRS0080			●	●	●	●	●	●			●	●	●	●
Full Lite 23x81 Cut Out for 22x80 Insert	DRS0080CO							●	●						●
Full Lite 21x81 Cut Out for 20x80 Insert	DRS0080CO					●									
Narrow Full Lite 15x81 Cut Out for 14x80 Insert	DRS0080CO			●											
3/4 2 Panels	DRS2980						●		●						●
2 Panels	DRS2B80						●		●						●
2 Panels Arch Panel	DRS2D80								●						●
2 Panels Plank Arch Panel	DRS2G80								●						
3/4 3 Panels	DRS3080								●						
True 4 Panels	DRS4180						●		●						
6 Panels	DRS6080					●	●		●				●		●
Flush Sidelite	SLS0080	●	●							●	●				
Full Sidelite 9x81 Cut Out for 8x80 Insert	SLS0080CO	●	●												
3/4 Lite Over 1 Panel 8x65 Cut Out for 7x64 Insert	SLS3080CO	●													

Purchase 22 each of any specific 8/0 Door Slab or Sidelite Sash to receive a Quantity Break Discount.



Flush 8/0 3/4 2 Panels 8/0 2 Panels 8/0 2 Panels Arch Panel 8/0 2 Panels Plank Arch Panels 8/0 3/4 3 Panels 8/0 True 4 Panels 8/0 6 Panels 8/0 Flush Sidelite Full Lite 3/4 Lite Over 1 Panels

See Specifications Page 21 for important information about cut-out sizes on the DRS6080



IMPACT DIRECT-GLAZED SLABS



- Full Length LVL Reinforcement (On both Hinge & Strike sides for extra rigidity)
- Insulated 1" Glass: available in Clear Low-E 366 or Translucent White Low-E
- Compression Molded Fiberglass Skin
- Integrally Molded Glass Stop
- High Density Polyurethane Foam
- Nova 90 door skin is a white brushed texture

All door panels are sold unfinished.



Full Lite 6/8 3/4 Lite Over 1 Panel 6/8 Full Lite 8/0 3/4 Lite Over 1 Panel 8/0



WHITE NOVA 90

DOOR NAME	ITEM#	HEIGHT	QTY BRK	2/0	2/6	2/8	2/10	3/0
Full Lite Low-E 366	DRS1SLIR	6/8	25	●	●	●	●	●
Full Lite Low-E 366	DRS1S80LIR	8/0	22	●	●	●	●	●
Full Lite White Translucent Low-E	DRS1STLIR	6/8	25		●	●		●
3/4 Lite White Translucent Low-E Over 1 Panel	DRS1ETSLIR	6/8	25					●
Full Lite White Translucent Low-E	DRS1ST80LIR	8/0	22			●		●
3/4 Lite White Translucent Low-E Over 1 Panel	DRS1E80TSLIR	8/0	22					●



NON-IMPACT DIRECT-GLAZED SLABS

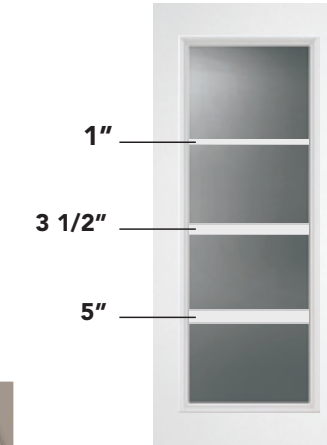

SDL BARS HAVE BRUSHED FINISH TO MATCH THE NOVA 90 BRUSHED SKIN



Full Lite 6/8 Full Lite 8/0



WHITE NOVA 90

DOOR NAME	ITEM#	HEIGHT	QTY BRK	2/0	2/6	2/8	2/10	3/0
Full Lite Low-E 272	DRS1SL	6/8	25	●	●	●	●	●
Full Lite Low-E 272	DRS1S80L	8/0	22	●	●	●	●	●



SPECIFICATIONS GLASS SIZE OPTIONS BY DOOR PANEL

SPECIFICATIONS GLASS SIZE OPTIONS BY DOOR PANEL

CUTOUTS ARE 1" LARGER THAN GLASS / INSERT SIZE

CUTOUTS ARE 1" LARGER THAN GLASS SIZE

6/8 FLUSH DRS/DRG00

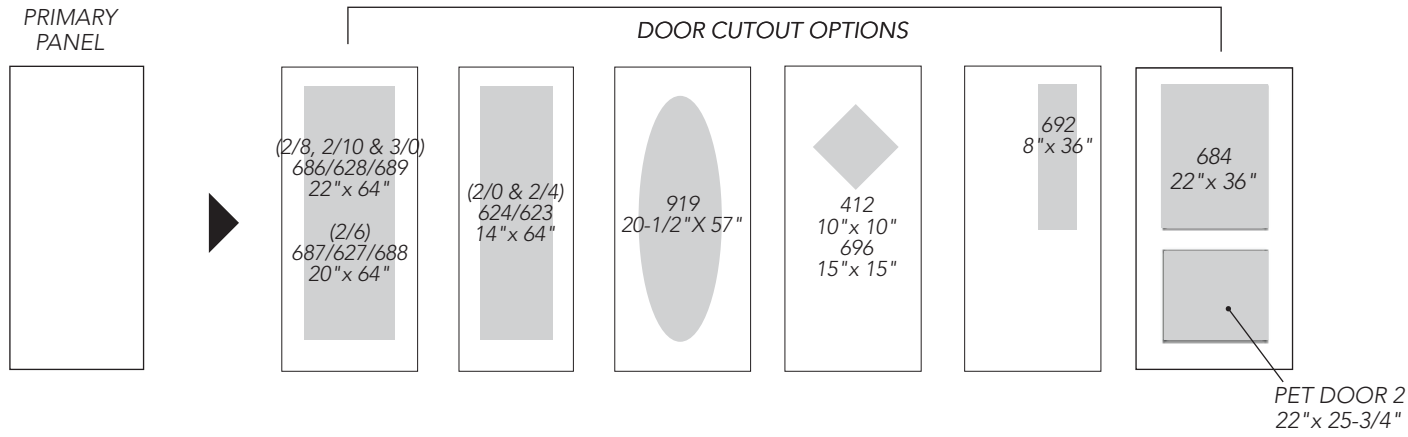

6/8 4-PANEL BLANK TOP DRS/DRG40

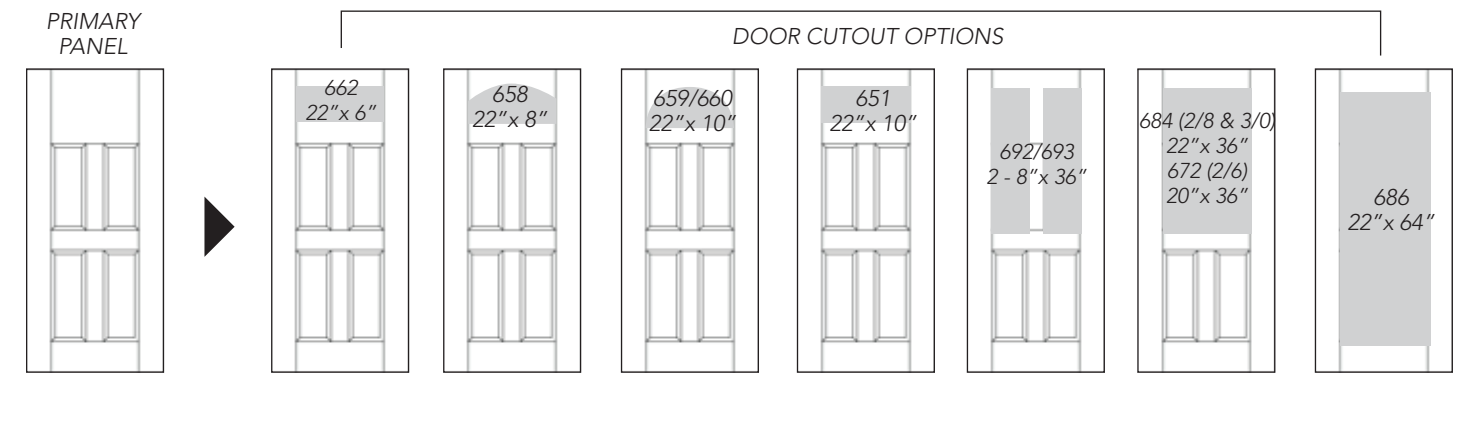

6/8 2-PANEL DRS/DRG29

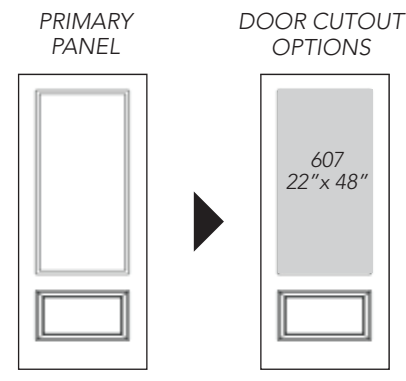

6/8 SHAKER DRS3F/DRF3F

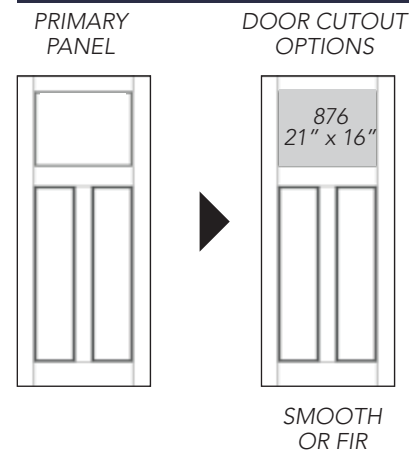

6/8 SHAKER DRSK2

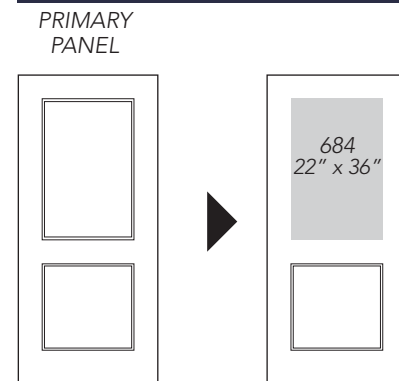

6/8 TRUE 4-PANEL DRS/DRG41

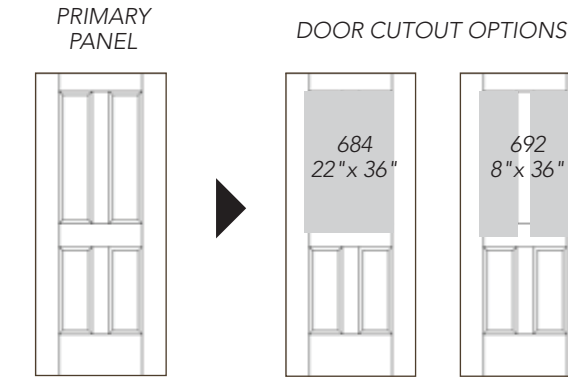

6/8 SIDELIGHTS SMOOTH/WOODGRAIN

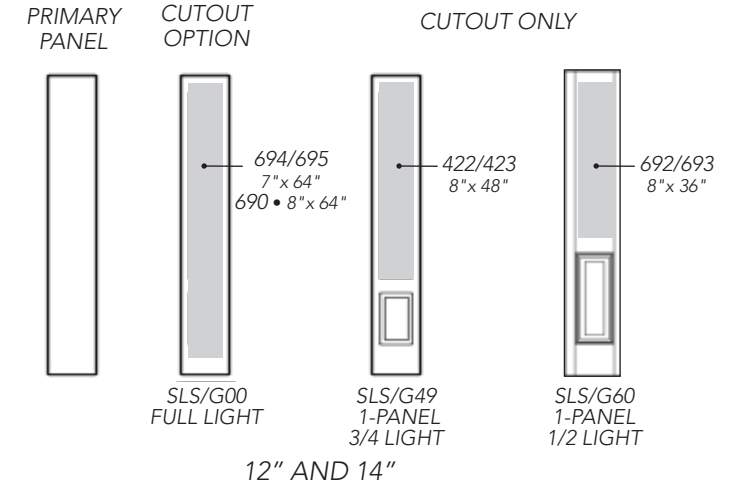

6/8 3/4 4-PANEL DRS/DRG49

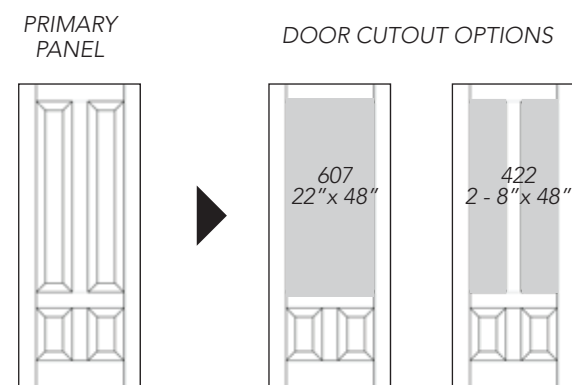

6/8 CRAFTSMAN DRS/DRG6C

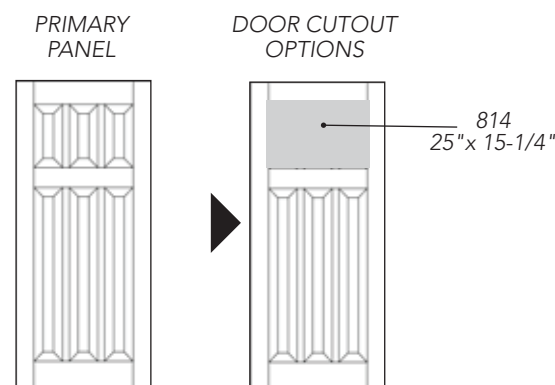

6/8 9-PANEL DRS/DRG90

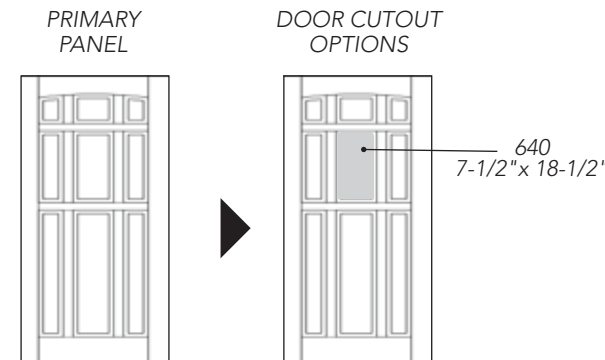

6/8 DRS/DRG80

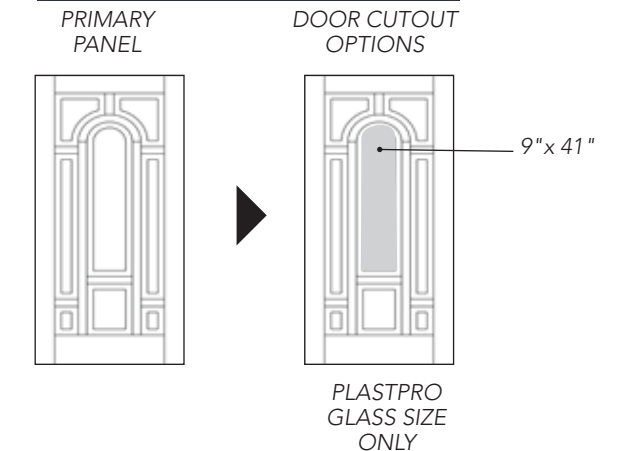

SPECIFICATIONS GLASS SIZE OPTIONS BY DOOR PANEL

SPECIFICATIONS GLASS SIZE OPTIONS BY DOOR PANEL

CUTOUTS ARE 1" LARGER THAN GLASS / INSERT SIZE

CUTOUTS ARE 1" LARGER THAN GLASS SIZE

6/8 2-PANEL SQUARE TOP DRS2B

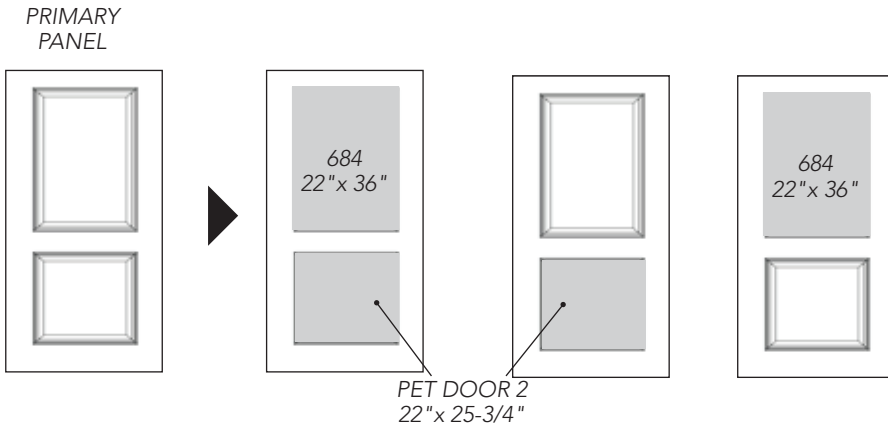

6/8 3/4 ELITE DRS3E

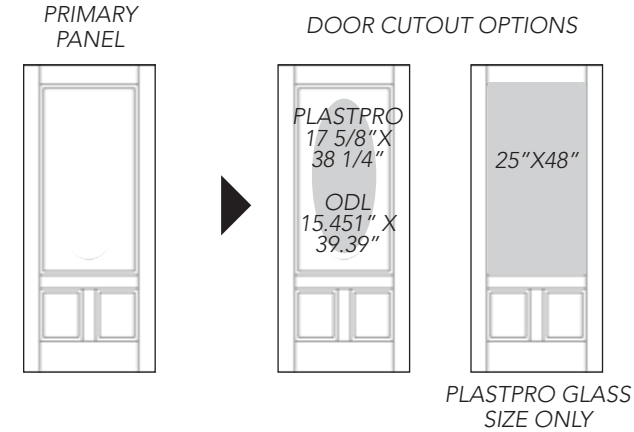

6/8 2-PANEL ARCH TOP DRS2D/DRS2G (PLANK)

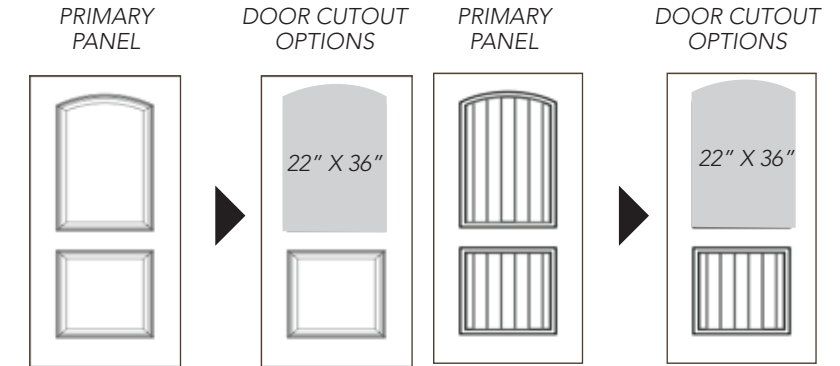

6/8 3/4 PREMIUM DRS/DRG3P

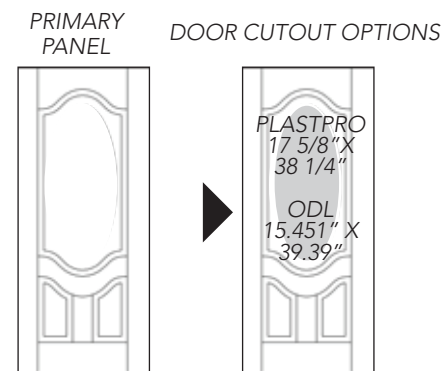

6/8 6-PANEL DRS/DRG60

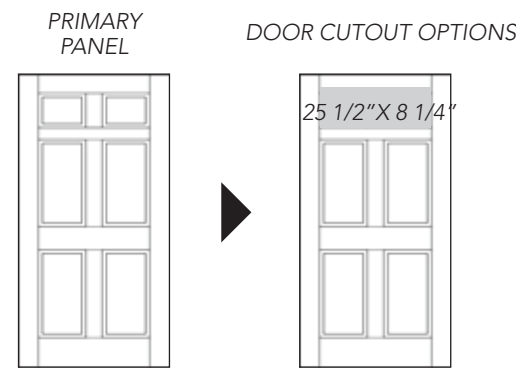

6/8 RUSTIC PLANK 2-PANEL ARCH DRA2A

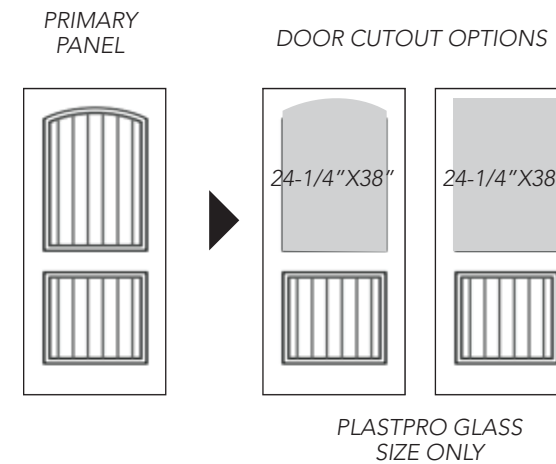

6/8 RUSTIC 2-PANEL ARCH DRA2D

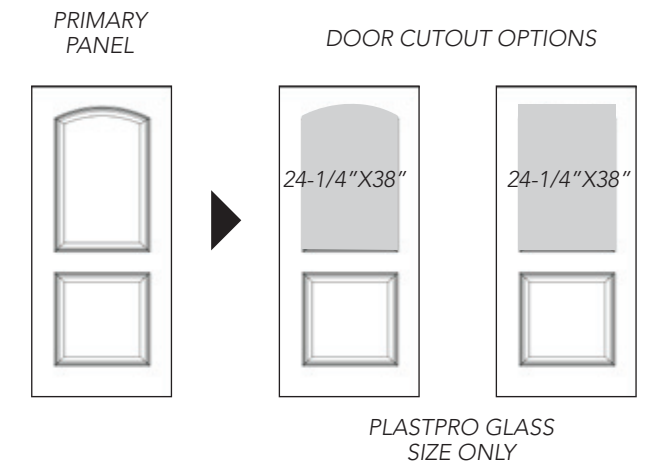

6/8 6-PANEL NARROW DRS/DRG63

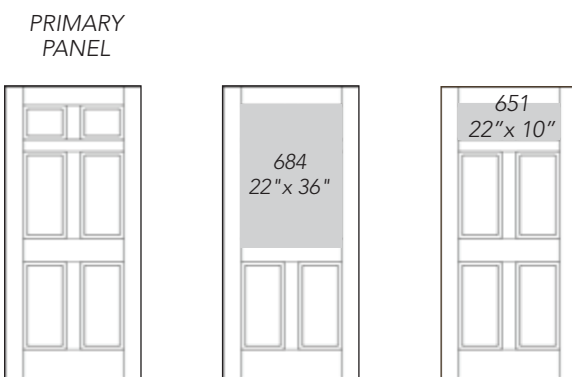

6/8 6-PANEL UTILITY DRS/DRG61

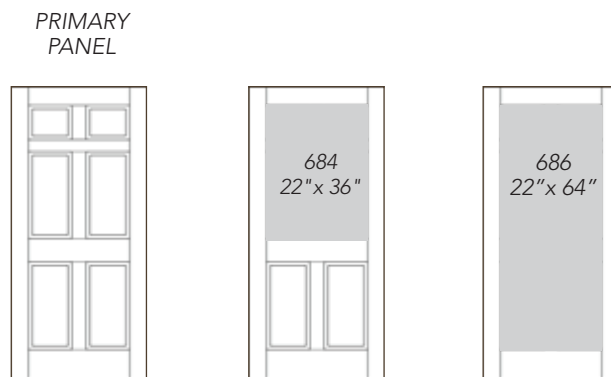

6/8 RUSTIC 2-PANEL SQUARE DRA2B

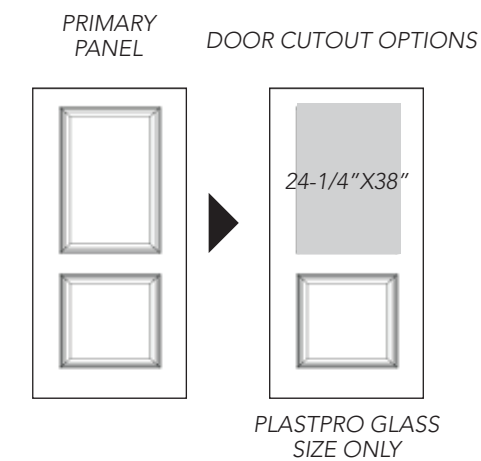

6/8 RUSTIC SIDELIGHT SLA2B

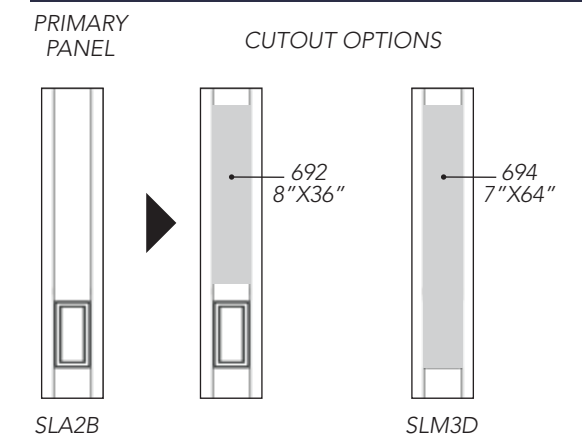

SPECIFICATIONS GLASS SIZE OPTIONS BY DOOR PANEL

SPECIFICATIONS GLASS SIZE OPTIONS BY DOOR PANEL

CUTOUTS ARE 1" LARGER THAN GLASS SIZE

CUTOUTS ARE 1" LARGER THAN GLASS SIZE

8/0 FLUSH DRS/DRG0080

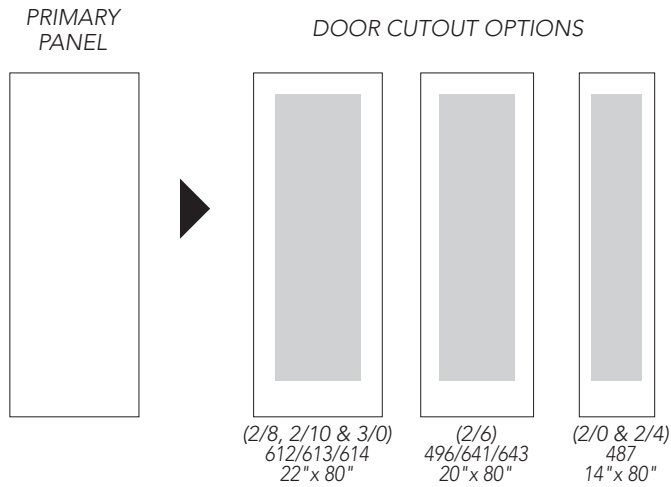

8/0 2-PANEL SQUARE TOP DRS/DRG2B80

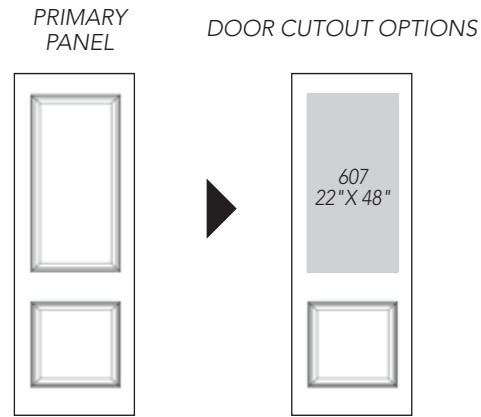

8/0 2-PANEL DRS/DRG2980

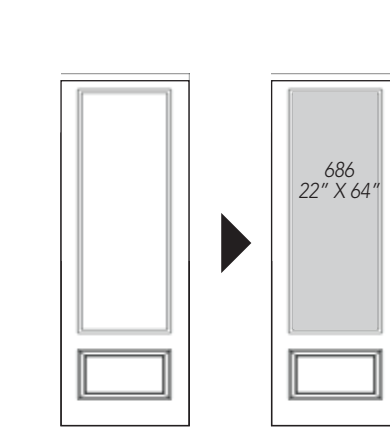

8/0 SIDELIGHT SLS/SLG/SLM

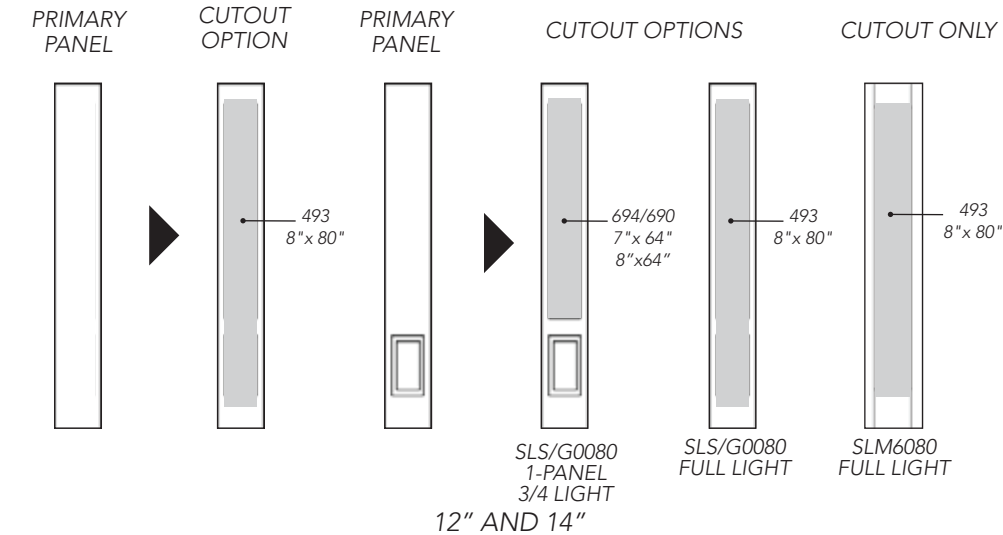

8/0 2-PANEL ARCH DRS/DRG2D80

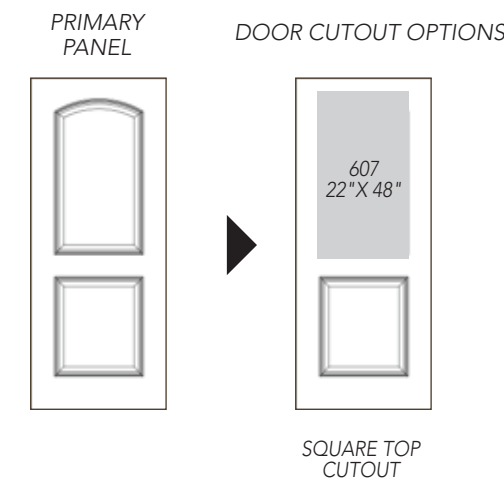

8/0 3-PANEL DRS/DRG3080

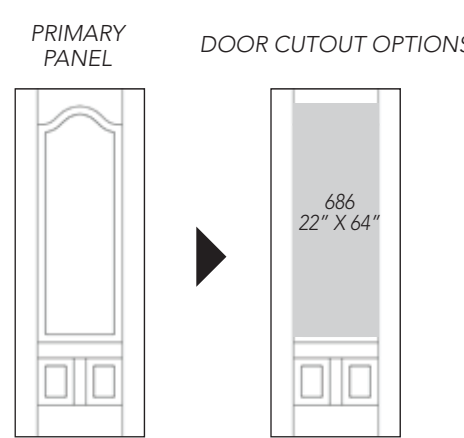

8/0 SHAKER DRS/DRF3F80

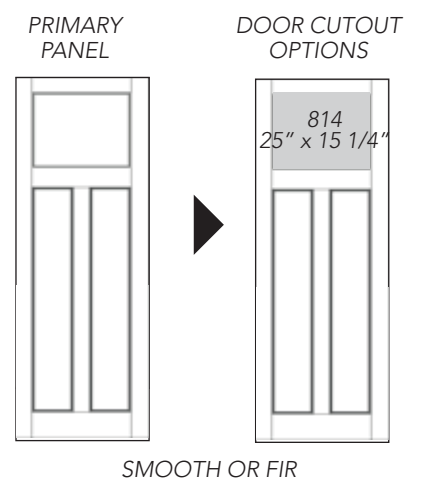

8/0 RUSTIC PLANK 2-PANEL SQUARE DRA2P80

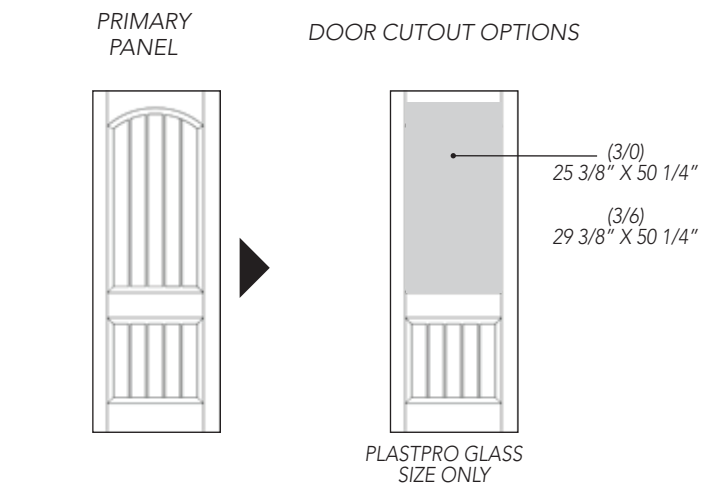

8/0 RUSTIC PLANK 2-PANEL ARCH DRA2A80

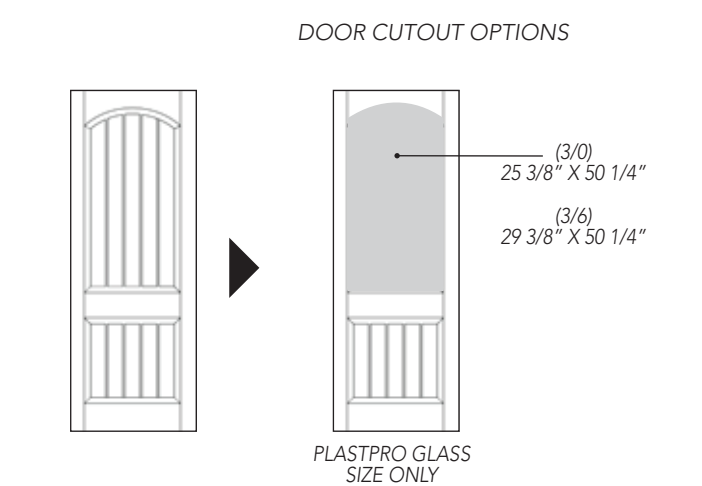

8/0 TRUE 4-PANEL DRS/DRG4180

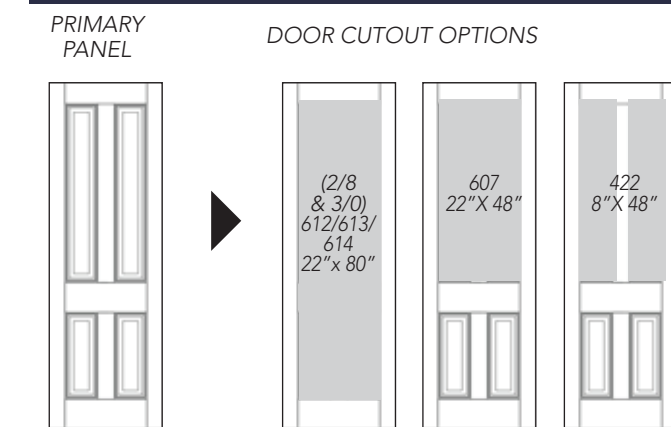

8/0 6-PANEL DRS/DRG6080

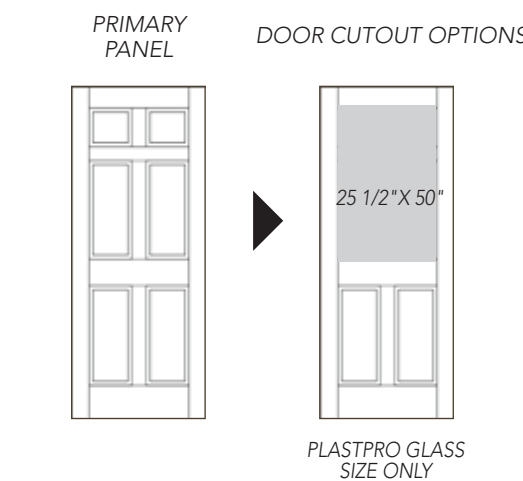

PLASTPRO DOOR SIZES			
WIDTH		HEIGHT	
2' 0"	23 3/4"	6' 8"	79 1/4"
2' 4"	27 3/4"	7' 0"	83 3/4"
2' 6"	29 3/4"	8' 0"	95 1/4"
2' 8"	31 3/4"		
2' 10"	33 3/4"		
3' 0"	35 3/4"		
3' 6"	41 3/4"		

■ Nominal Size ■ Actual Size
Door Thickness: 1 3/4"

PLASTPRO SIDELITE SIZES			
WIDTH		HEIGHT	
1' 0"	11 1/4"	6' 8"	79 1/4"
1' 2"	13 3/4"	7' 0"	83 3/4"
		8' 0"	95 1/4"

■ Nominal Size ■ Actual Size
Sidelite Thickness: 1 3/4"

REPLACEMENT BOTTOM RAIL
(Suggested for door cut downs of more than 5/8")

ITEM#	SIZE	DESCRIPTION
CRRLT3000	1.585" x 1.25" x 34.905"	For Plastpro standard slabs 3/0 or less
CRRLT3000IP	1.485" x 1.25" x 34.905"	For Plastpro IR (HVHZ) slabs 3/0 or less



PET DOOR INSERTS

PET DOOR INSERTS

Insulated Pet Door



NEW!

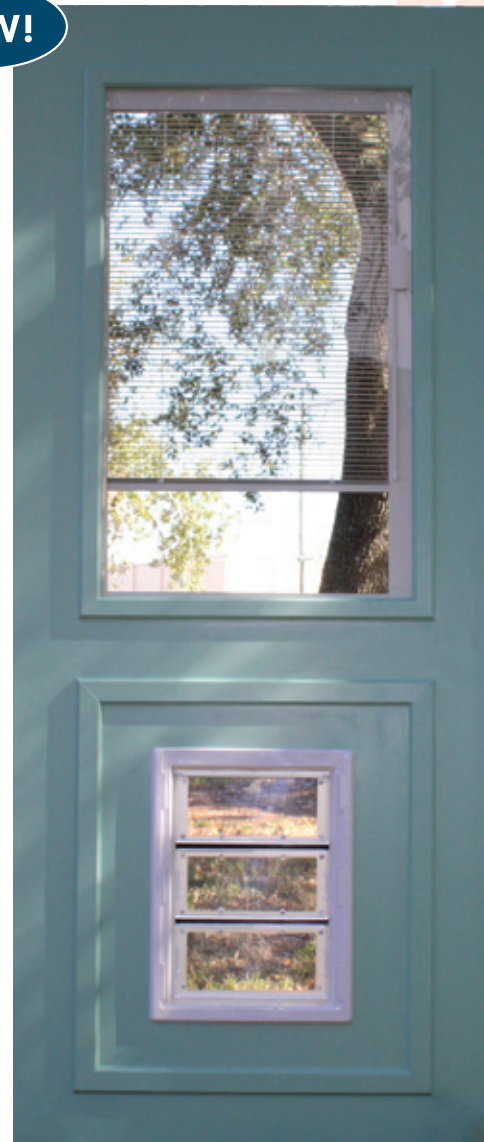

1/2 Blind Lite Over Guard Door Pet Door # 2



Don't keep your best friend waiting!

- For pets up to 90 lbs
- This system meets ASTM F588 300 lbs forced entry
- Meets structural, cycle, impact, and water testing for Florida's WBD regions. DP rating: Inswing +50 /-60 Outswing +45 /-45
- Low maintenance, energy efficient, extremely durable LEXAN flap and frame



The flexible LEXAN flap uses durable vinyl weatherstrip and rare earth magnets to create an energy efficient seal when not in use.

The flap is clear so you and your pet can see whats on the other side

Available in the following flap sizes:
 Large Pet: 10-1/4" wide X 15-1/4" high
 Medium Pet: 6-5/8" wide X 11-1/4" high

Each system comes with removable exterior and interior barrier panels. The interior barrier panel can be slid into place when you want to restrict your pet's access. The exterior barrier is secured with a key lock to keep small intruders and large storms out.



Insulated Pet Door

(continued)

Guard Dog # 2 Pet Door



Interior view



Exterior View

These Pet Doors come ready to easily install directly into a 23" wide by 26-3/4" tall door cut-out (1-3/4" door thickness). They simply screw in place just like a doorglass insert! Screw hole plugs are provided for a clean finished look. You can cut out a flush door, or this cut-out size fits nicely over the bottom panel of the DRS2B 6/8 2 Panel Door. Placing the cut-out at the bottom of your slab will leave you room for any 22x36 door-glass insert above it.

Examples of various Pet door applications:



1/2 Blind Lite Over GDPD2LG



1/2 Lite Over GDPD2LG

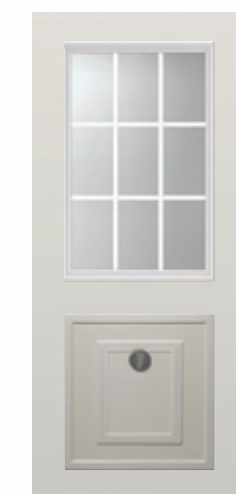

1/2 GBG Lite Over GDPD2LG



GDPD2LG Installed in DRS2B

Impact Pet Doors come packaged with installation hardware

ITEM#	SIZE	DESCRIPTION	FINISH
GDPD2LG	Large	Guard Dog Impact Pet Door 2	Smooth White
GDPD2MD	Medium	Guard Dog Impact Pet Door 2	Smooth White

VENTILATING DOORGLASS

DOOR LOUVERS

IMPACT WINDSERTS

Windserts come packaged with all required installation hardware. These do not install like a doorglass insert. The process is more involved due to their operating sashes and screens. For installation instructions please refer to the Resources page on our website.

Optional Impact Security Screen

SKU	Size
WSS2264	22" x 64"



- Premium grade high tensile 304 stainless security mesh
- Offers insect control, and impact resistance
- Allows ventilation without compromising security
- Available for all door sizes; 22 x 64 is stocked ,all other sizes are available via QuickShip
- All Windserts are factory packaged with standard fiberglass screens; this impact screen option has to be specified when ordering.



The following optional glass types are available.

Low-E	Milky White	Obscure	Gray	Turtle*

*Special Order

Examples of various applications:



WI2264 Installed in DRS00

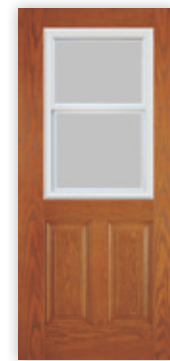

WI2236 Installed in DRG40

SKU	Size	DESCRIPTION
WI1436CL	14" x 36"	Clear
WI1436MW	14" x 36"	Milky White
WI1436OBS	14" x 36"	Obscure

SKU	Size	DESCRIPTION
WI1836CL	18" x 36"	Clear
WI1836LE	18" x 36"	Low-E
WI1836MW	18" x 36"	Milky White
WI1836OBS	18" x 36"	Obscure

SKU	Size	DESCRIPTION
WI2036CL	20" x 36"	Clear
WI2036LE	20" x 36"	Low-E
WI2036MW	20" x 36"	Milky White
WI2036OBS	20" x 36"	Obscure
WI2064CL	20" x 64"	Clear

SKU	Size	DESCRIPTION
WI2236CL	22" x 36"	Clear
WI2236LE	22" x 36"	Low-E
WI2236MW	22" x 36"	Milky White
WI2236OBS	22" x 36"	Obscure
WI2264CL	22" x 64"	Clear
WI2264LE	22" x 64"	Low-E
WI2264MW	22" x 64"	Milky White

Other sizes available through QuickShip: 14x64, 18x64, 20x64, 22x48

PVC VENTILATING

PVC Louvers come packaged with all required installation hardware. These louvers are designed to install like a doorglass insert- with the interior and exterior frames screwing into each other to hold the louver in place. Each louver also comes packaged with a Fiberglass Insect Screen.



PVC2264 Installed in DRS00

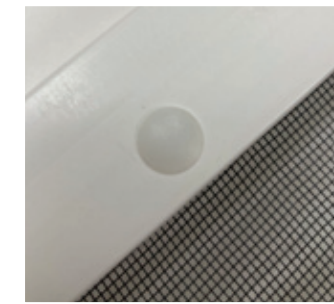

Fiberglass Insect Screen & Screw Hole Plugs

FOR 1-3/4" DOOR ONLY

ITEM#	SIZE
PVC1212FS134	12" x 12"
PVC2264FS134	22" X 64"
PVC2424FS134	24" x 24"
PVC2448FS134	24" x 48"
PVC2080FS134	20" x 80"

Custom sizes available by Special Order.

ALUMINUM VENTILATING

Aluminum Louvers come packaged with all required installation screws. These louvers are designed to install by having both their interior and exterior frames screw-mounted into the door skin. This method may require additional wood blocking to be installed inside the door skin around the cut-out on exterior door applications. This wood blocking does not come packaged with the louvers.



A1212D1M

FULL-LENGTH LOUVERS HAVE ONE VERTICAL AND THREE HORIZONTAL SUPPORTS.

ITEM#	DESCRIPTION
A1212D1M	12" x 12"
A1818D1M	18" x 18"
A2020D1M	20" x 20"
A2412D1M	24" x 12"
A2424D1M	24" x 24"

Heavy-duty louvers & custom sizes are available by Special Order.

ADHESIVE SDL BARS



CUSTOM GLASS PRODUCTS

Give any One Lite door a beautiful Simulated Divided Lite look by simply installing these adhesive backed PF SDL Bars on the glass surface. These can be used as a cost-effective way to get a sharp modern look that meets regional Impact Testing guidelines. They come in different profiles and grain types to match the most common insert frames in the industry.

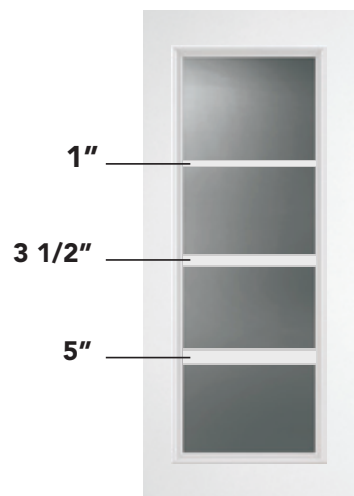

SMOOTH WHITE MI PROFILE

SKU	DESCRIPTION	QTY BRK
SDLBAR1WH96	96" Length x 1" Width x 3/16" Projection	7
SDLBAR312WH96	96" Length x 3-1/2" Width x 3/8" Projection	7
SDLBAR5WH96	96" Length x 5" Width x 3/8" Projection	7



TEXTURED WHITE MI PROFILE MATCHES ODL ZEEL

SKU	DESCRIPTION	QTY BRK
SDLBAR1ZLWH96	96" Length x 1" Width x 3/16" Projection	7
SDLBAR312ZLWH96	96" Length x 3-1/2" Width x 3/16" Projection	7
SDLBAR5ZLWH96	96" Length x 5" Width x 3/16" Projection	7



BRUSHED WHITE SR PROFILE MATCHES PLASTPRO NOVA90 SKIN

SKU	DESCRIPTION	QTY BRK
SDLBAR1NVWH96	96" Length x 1" Width x 1/4" Projection	7
SDLBAR312NVWH96	96" Length x 3-1/2" Width x 1/4" Projection	7
SDLBAR5NVWH96	96" Length x 5" Width x 1/4" Projection	7



WOODGRAIN TEXTURED TAN MI PROFILE

SKU	DESCRIPTION	QTY BRK
SDLBAR1OA96	96" Length x 1" Width x 3/16" Projection	7
SDLBAR312OA96	96" Length x 3-1/2" Width x 3/8" Projection	7
SDLBAR5OA96	96" Length x 5" Width x 3/8" Projection	7



FRAMES & MOLDINGS

plastpro® PF FRAMES™
Doorframes & Moldings

Plastpro's Polyfiber (PF) Door Frames are an innovative alternative to traditional door jambs. Their uniquely formulated door frame matches the beauty of wood, but requires less maintenance and will last for a lifetime. The material is highly durable, long-lasting, and is more thermally resistant than either wood or metal. This advanced system can be machined and installed the same way as traditional wood jambs- with no added hassles. When a fiberglass door is used together with a PF Frame system, they create an enhanced, weather and wear resistant entryway.

The closed cellular structure of our composite frames ensures that the molding will not absorb moisture, and that the frame will resist splitting, rotting and insect damage.

- Closed Cellular Structure
- Twice The Screw-Holding Power of Wood
- Rigid Polyfiber Formulation – Composite
- Easily Machined



FRAMES & MOLDINGS

FRAMES & MOLDINGS

SMOOTH WHITE PRIMED BLANK PF JAMBS

Blank Jambs all come with head and sill dado; weatherstripping not included.

ITEM#	SIZE	QTY BRK
PFWSLJ	82" x 4-9/16"	160
PFWSLJ8	98" x 4-9/16"	160
PFWSLJ5	82" x 5-1/4"	70
PFWSLJ85	98" x 5-1/4"	70
PFWSLJ6	82" x 6-9/16"	96
PFWSLJ86	98" x 6-9/16"	96
PFWSLJ7	82" x 7-1/4"	80
PFWSLJ87	98" x 7-1/4"	80

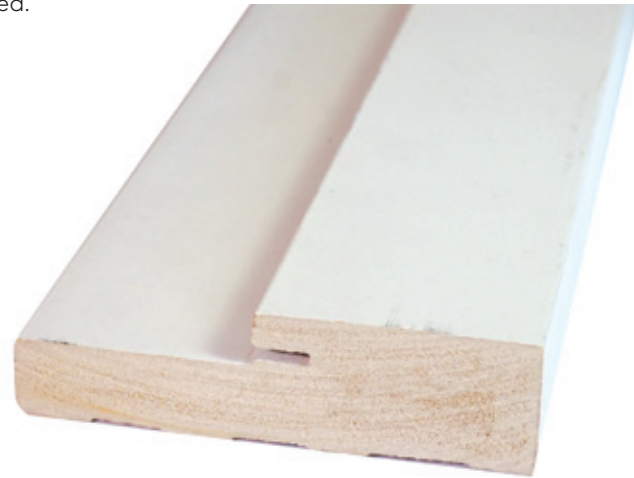

SMOOTH WHITE PRIMED PF BRICKMOLD AND MOLDING

ITEM#	SIZE	DESCRIPTION	QTY BRK
PFWBM17685	85" x 1-1/2" x 5/8"	FL Brickmold	800
PFWBM176102	102" x 1-1/2" x 5/8"	FL Brickmold	800
PFWBM18085	85" x 3/16" x 2"	Brickmold	400
PFWBM180102	102" x 1-3/16" x 2"	Brickmold	400
PFMTS24M10000	100" x 2-1/2"	Mullion Strip	1280
PFWSSM100	100"x11/32"x9/16"	Stop Molding	3465

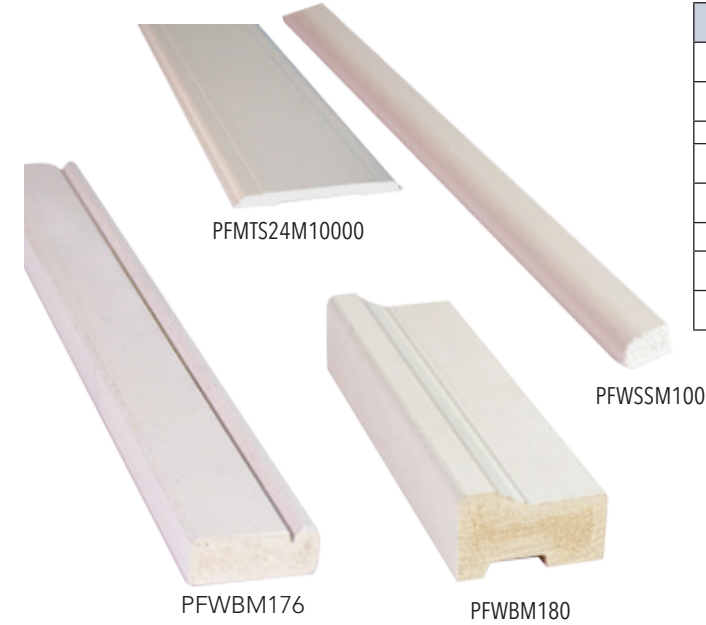

TEXTURED TAN WOODGRAIN BLANK PF JAMBS

Blank Jambs all come with head and sill dado; weatherstripping not included.

ITEM#	SIZE	QTY BRK
PFSLJ	82" x 4-9/16"	160
PFSLJ8	98" x 4-9/16"	160
PFSLJ5	82" x 5-1/4"	70
PFSLJ85	98" x 5-1/4"	70
PFSLJ6	82" x 6-9/16"	96
PFSLJ86	98" x 6-9/16"	96
PFSLJ87	98" x 7-1/4"	80



TEXTURED TAN WOODGRAIN PF BRICKMOLD AND MOLDING

ITEM#	SIZE	DESCRIPTION	QTY BRK
PFBM176102	102" x 1-1/2" x 5/8"	FL Brickmold	800
PFBM180102	102" x 1-3/16" x 2"	Brickmold	400
PFMTG24M10000	100" x 2-1/2"	Mullion Strip	1280
PFSSM100	100" x 11/32" x 9/16"	Stop Molding	3465



HEAD & SILL DADO SPECS

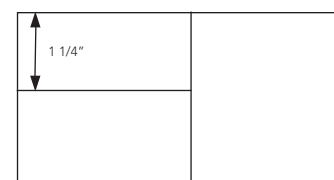

HEAD DADO

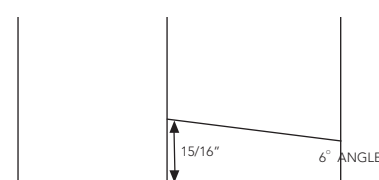

SILL DADO

ALUMINUM STRUCTURAL MULLIONS

ITEM#	SIZE	DESCRIPTION	MIN QTY
MULL1414RECT12W	1" x 4" x 1/4" x 12'	Rectangular White	1
MULLCLIP1	3-3/8" x 8-1/4"	For mounting MULL1414 (Each mullion requires 2 clips)	2
MULL2414RECT12W	2" x 4" x 1/4" x 12'	Rectangular White	1
MULLCLIP2	3-3/8" x 5-1/2"	For mounting MULL2414 (Each mullion requires 2 clips)	2

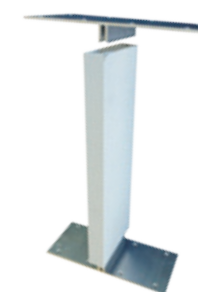

FINISHING SOLUTIONS

ALUMINUM ASTRAGALS

Paint & Stain Kits **NEW!**

Each kit contains everything you need to finish one prehung door and two sidelites (or one double door unit).

- Specifically designed for Fiberglass PH Entry System and its various components
- Eco-friendly, completely water based system
- UV inhibiting pigments for increased energy efficiency and longer lasting beauty
- Available in 9 paint colors and 5 stain colors, as well as in a satin clear coat for added protection



Paint Kits

ITEM#	DESCRIPTION
BHIPKCOLWHT	Colonial White
BHIPKBLKONX	Black Onyx
BHIPKBCHSND	Beach Sand
BHIPKSNDRN	Sandstone Green
BHIPKBLUSEA	Deep Blue Sea
BHIPKBLUBRD	Blue Bird
BHIPKSLTGRY	Slate Grey
BHIPKSCRBRK	Scarlet Brick
BHIPKDRKBRZ	Dark Bronze
BHISKPKSTNCC	Satin Clear Coat



Stain Kits

ITEM#	DESCRIPTION
BHISKESPRESSO	Espresso
BHISKCHARCOAL	Charcoal
BHISKDRIFTWOOD	Driftwood
BHISKPECAN	Pecan
BHISKCHERRY	Cherry
BHISKPKSTNCC	Satin Clear Coat

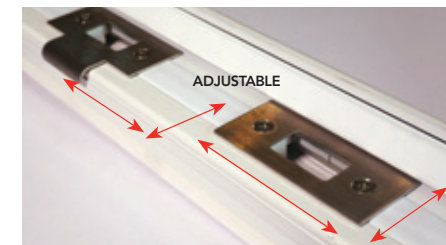

4-way Adjustable (horizontal and vertical) Strike latch plates



Flip lever locks



Slide bolt with machined center punch allows for precise bolt location and ease of installation.

Add on an Astragal Security Strip to any outswing double door combination for added security and a clean finished appearance- eliminating the reveal between the doors.

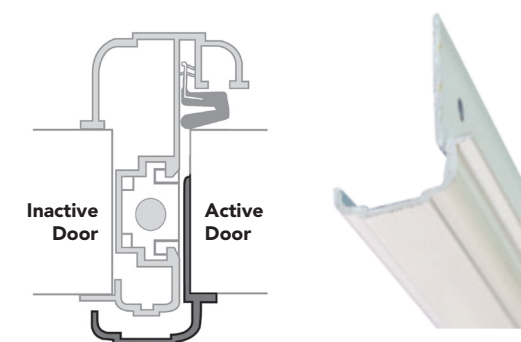

DLP Aluminum T-astragals are a stand-out amongst competitors in regards to Florida building code testing. Their rigid design will provide your double door entryway with increased security, as well as superior weather and pest protection. Designed for easy installation and operation, they have multiple advanced features:

- Slide bolt with patented flip lever locking for security
- 4 way adjustable strikes
- Pin point punch
- Available in white or bronze finish
- Also available in a cost effective paintable/ stainable tan finish option

ASTRAGAL SECURITY STRIPS

ITEM#	DESCRIPTION	FINISH
ASTSS68LOS	6/8 Left Hand Outswing Door	White
ASTSS68ROS	6/8 Right Hand Outswing Door	White
ASTSS80LOS	8/0 Left Hand Outswing Door	White
ASTSS80ROS	8/0 Right Hand Outswing Door	White

CUSTOM SIZES AND SPECIFICATIONS AVAILABLE BY SPECIAL ORDER.

ALUMINUM ASTRAGALS

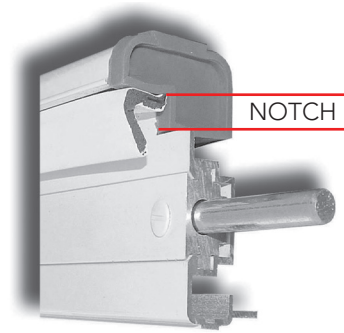

**OUTSWING ASTRAGALS HAVE SILL AND HEAD NOTCH
INSWING ASTRAGALS HAVE ONLY HEAD NOTCH**

STOCK SIZE NOTCHES LISTED BELOW, OTHER NOTCH SIZES CAN BE SPECIAL ORDERED.

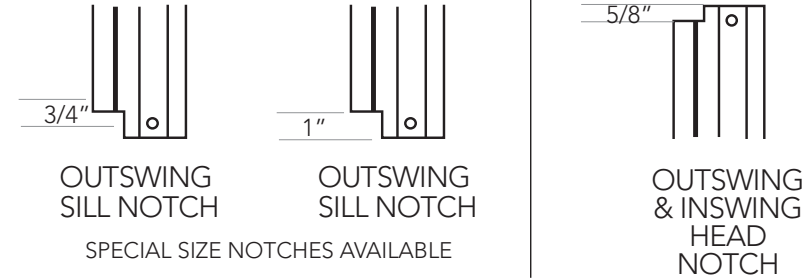

All Astragals on this page come packaged with installation hardware.

STANDARD STRIKE 6/8 WHITE (WITH WHITE WEATHERSTRIP)

ITEM#	DESCRIPTION	QTY BRK
AST68LISW	79-5/16" Left Hand Inswing	6
AST68RISW	79-5/16" Right Hand Inswing	6
AST68LOSW	79-5/16" Left Hand Outswing	6
AST68ROSW	79-5/16" Right Hand Outswing	6

STANDARD STRIKE 8/0 WHITE (WITH WHITE WEATHERSTRIP)

ITEM#	DESCRIPTION	QTY BRK
AST80LISW	95-5/16" Left Hand Inswing	6
AST80RISW	95-5/16" Right Hand Inswing	6

STANDARD STRIKE NON-HANDED WHITE (WITH WHITE WEATHERSTRIP)

ITEM#	DESCRIPTION	QTY BRK
AST68NOHAND	80" No Sill or Head Notch	6
AST80NOHAND	96" No Sill or Head Notch	6

CUSTOM SIZES AND SPECIFICATIONS AVAILABLE BY SPECIAL ORDER.



ALUMINUM ASTRAGALS

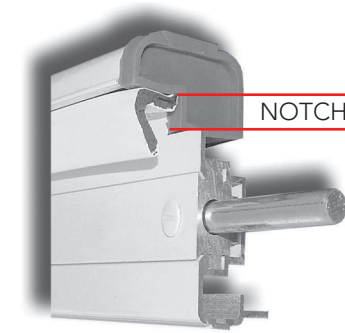

**OUTSWING ASTRAGALS HAVE SILL AND HEAD NOTCH
INSWING ASTRAGALS HAVE ONLY HEAD NOTCH**

STOCK SIZE NOTCHES LISTED BELOW, OTHER NOTCH SIZES CAN BE SPECIAL ORDERED.

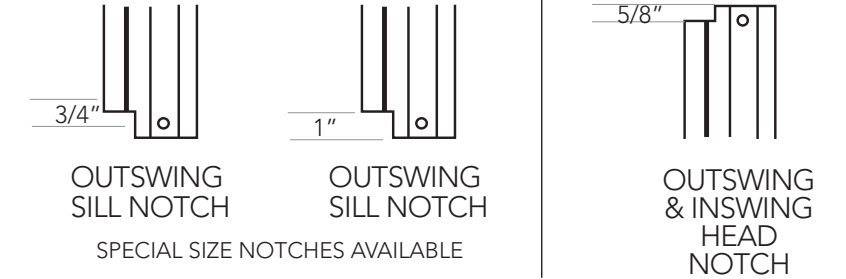

All Astragals on this page come packaged with installation hardware.

ADJUSTABLE STRIKE 6/8 WHITE (WITH WHITE WEATHERSTRIP)

ITEM#	DESCRIPTION	QTY BRK
AST68LISW-ASP	79-5/16" Left Hand Inswing	6
AST68RISW-ASP	79-5/16" Right Hand Inswing	6
AST68LOSW-ASP	79-5/16" Left Hand Outswing	6
AST68ROSW-ASP	79-5/16" Right Hand Outswing	6
AST68LOSW34-ASP	79-5/16" 3/4" Notch Left Hand Outswing	6
AST68LOSW78-ASP	78" 1" Notch Left Hand Outswing	6
AST68ROSW78-ASP	78" 1" Notch Right Hand Outswing	6



ADJUSTABLE STRIKE 6/8 TAN STAINABLE (WITH BRONZE WEATHERSTRIP)

ITEM#	DESCRIPTION	QTY BRK
ASTS68LISB-ASP	79-5/16" Left Hand Inswing	6
ASTS68RISB-ASP	79-5/16" Right Hand Inswing	6
ASTS68LOSB-ASP	79-5/16" Left Hand Outswing	6
ASTS68ROSB-ASP	79-5/16" Right Hand Outswing	6



CUSTOM SIZES AND SPECIFICATIONS AVAILABLE BY SPECIAL ORDER.

ALUMINUM ASTRAGALS

OUTSWING ASTRAGALS HAVE SILL AND HEAD NOTCH
INSWING ASTRAGALS HAVE ONLY HEAD NOTCH

STOCK SIZE NOTCHES LISTED BELOW, OTHER NOTCH SIZES CAN BE SPECIAL ORDERED.

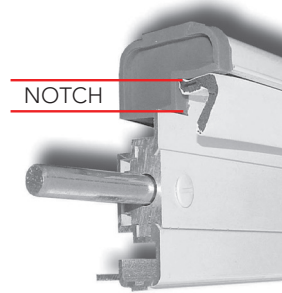
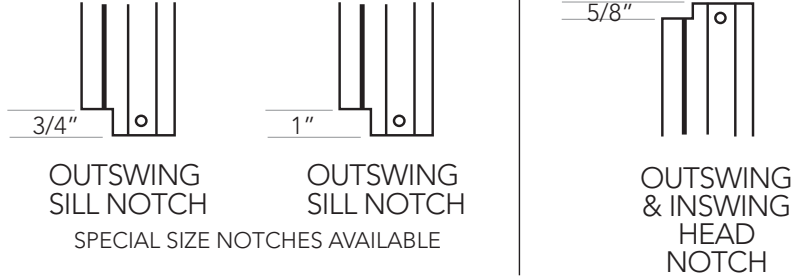

ADJUSTABLE STRIKE 8/0 WHITE (WITH WHITE WEATHERSTRIP)

ITEM#	DESCRIPTION	QTY BRK
AST80LISW-ASP	95-5/16" Left Hand Inswing	6
AST80RISW-ASP	95-5/16" Right Hand Inswing	6
AST80LOSW-ASP	95-5/16" Left Hand Outswing	6
AST80ROSW-ASP	95-5/16" Right Hand Outswing	6
AST80LOSW34-ASP	95-5/16" 3/4" Notch Left Hand Outswing	6
AST80ROSW34-ASP	95-5/16" 3/4" Notch Right Hand Outswing	6

ITEM#	DESCRIPTION	QTY BRK
12OCAST80LISWASP	95-5/16" 12" On Center Left Hand Inswing	6
12OCAST80RISWASP	95-5/16" 12" On Center Right Hand Inswing	6

ADJUSTABLE STRIKE 8/0 TAN STAINABLE (WITH BRONZE WEATHERSTRIP)

ITEM#	DESCRIPTION	QTY BRK
ASTS80LISB-ASP	95-5/16" Left Hand Inswing	6
ASTS80RISB-ASP	95-5/16" Right Hand Inswing	6
ASTS80LOSB-ASP	95-5/16" Left Hand Outswing	6
ASTS80ROSB-ASP	95-5/16" Right Hand Outswing	6

TRILENNIUM PREPPED 6/8 & 8/0

ITEM#	DESCRIPTION	QTY BRK
AST68LISW/WFP	79-5/16" Left Hand Inswing White	6
AST68RISW/WFP	79-5/16" Right Hand Inswing White	6
AST80LISW/WFP	95-5/16" Left Hand Inswing White	6
AST80RISW/WFP	95-5/16" Right Hand Inswing White	6
ASTS68LISB/WFP	79-5/16" Left Hand Inswing Tan Stainable	6
ASTS68RISB/WFP	79-5/16" Right Hand Inswing Tan Stainable	6
ASTS80LISB/WFP	95-5/16" Left Hand Outswing Tan Stainable	6
ASTS80RISB/WFP	95-5/16" Right Hand Outswing Tan Stainable	6

CUSTOM SIZES AND SPECIFICATIONS AVAILABLE BY SPECIAL ORDER.

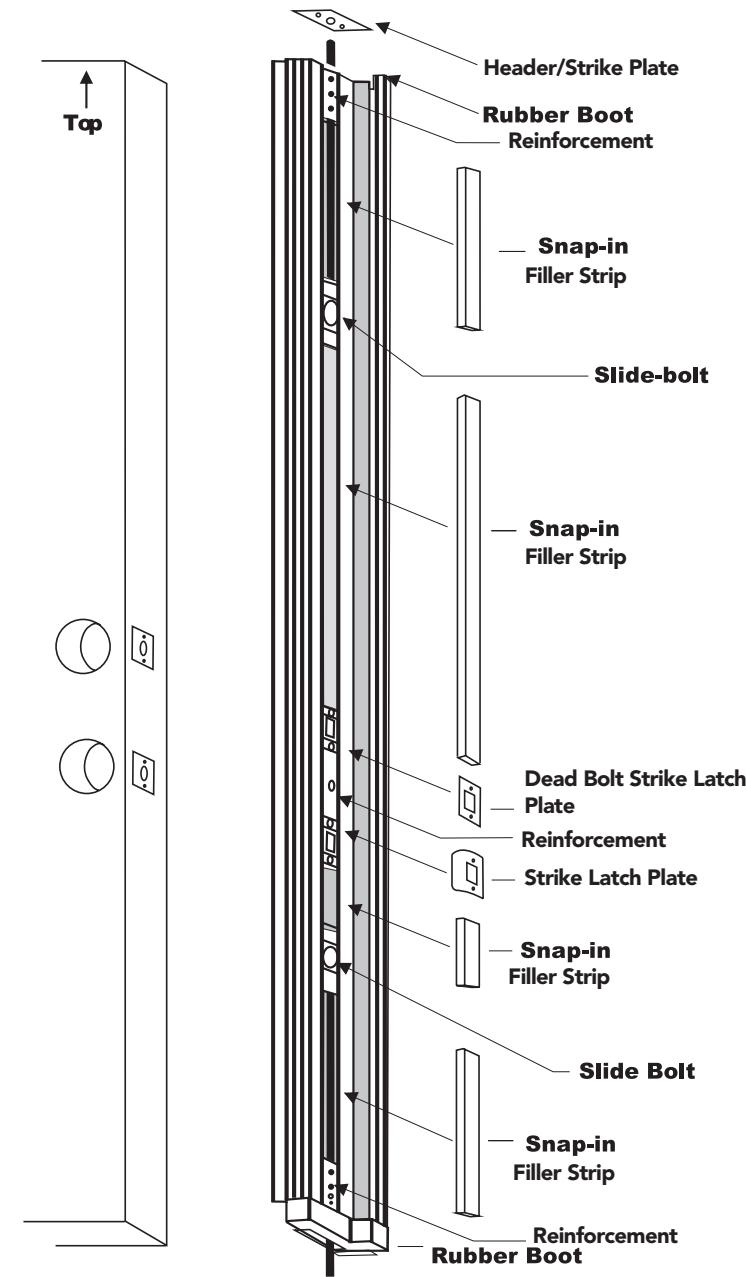
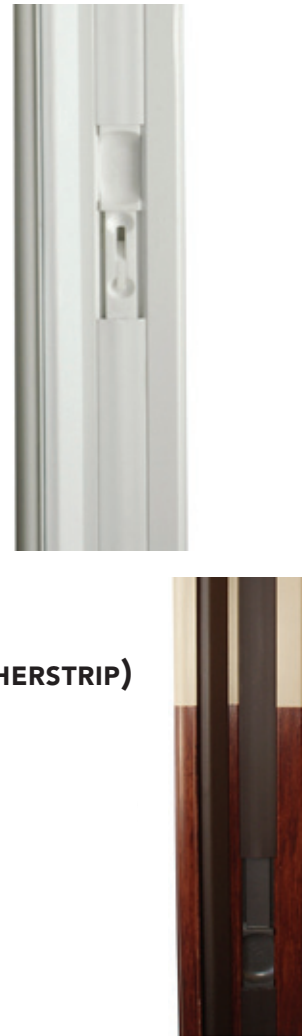

ALUMINUM ASTRAGALS

PARTS & ACCESSORIES

*Comes packaged with installation screws.

ITEM#	DESCRIPTION	FINISH
ASTHSS	Astragal Header/ Sill Strike Plate	Dull Chrome
ASTHW	Astragal Boot Hardware Bag	----
ASTFS86	86" Astragal Filler Strip	White
ASTFSB86	86" Astragal Filler Strip	Bronze
ASTFSHW	Astragal Filler Strip Hardware Bag	White
ASTSBBRZ	Astragal Filler Strip Hardware Bag	Bronze
ASTGLLG	Astragal Glue 4 oz Bottle	Clear
ASTASPDBB	Adjustable Strike Deadbolt Latch Plate*	Oil Rubbed Bronze
ASTASPDBS	Adjustable Strike Deadbolt Latch Plate*	Satin Nickel
ASTASPDKB	Adjustable Strike Lock Latch Plate*	Oil Rubbed Bronze
ASTASPDKS	Adjustable Strike Lock Latch Plate*	Satin Nickel
ASTISBL	Astragal Boot Left Hand Inswing	Grey
ASTISBR	Astragal Boot Right Hand Inswing	Grey
ASTOSBL	Astragal Boot Left Hand Outswing	Grey
ASTOSBR	Astragal Boot Right Hand Outswing	Grey
ASTSBP	Astragal Slide Bolt Flip Lever	White
ASTSBR	Astragal Slide Bolt Receiver	Black



ASTHW

All Astragals on this page come packaged with installation hardware.

ALUMINUM THRESHOLDS

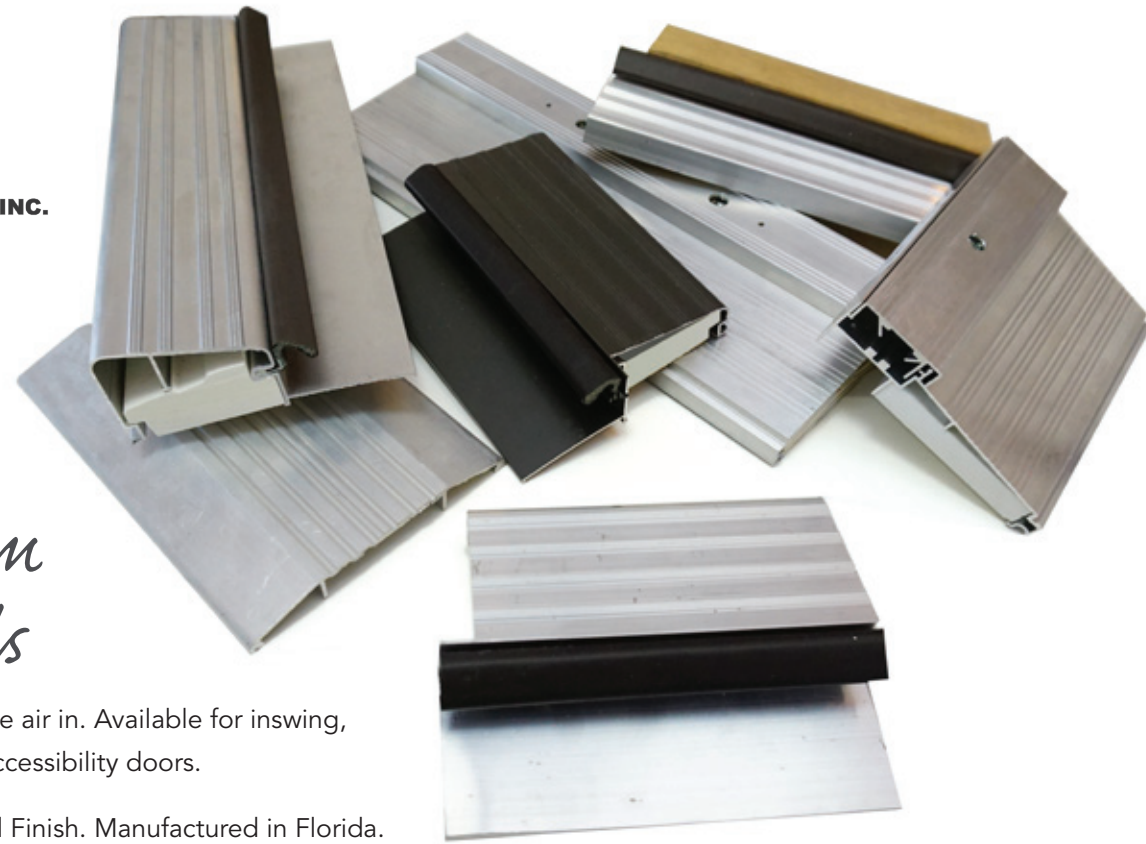

Aluminum Thresholds

Keep the bugs out and the air in. Available for inswing, outswing and handicap accessibility doors.

Available in Bronze or Mill Finish. Manufactured in Florida.

BUMPER AND SADDLE

Outswing Low Bumper 3-1/8"W x 5/8"H

ITEM#	LENGTH	FINISH
LB30	36-1/2"	Mill
LB60	72-1/2"	Mill

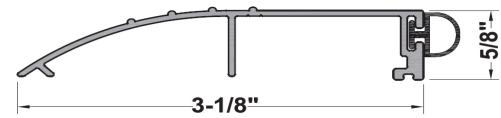

Outswing High Bumper 3-1/8"W x 1"H

ITEM#	LENGTH	FINISH
HB28	32-1/2"	Mill
HB30	36-1/2"	Mill
HB60	72-1/2"	Mill

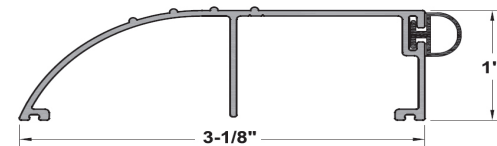

Inswing Low Saddle 3-17/32"W x 11/16"H

ITEM#	LENGTH	FINISH
LS30	36-1/2"	Mill

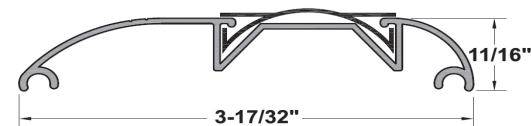

Inswing High Saddle 3-17/32"W x 15/16"H

ITEM#	LENGTH	FINISH
HS30	36-1/2"	Mill

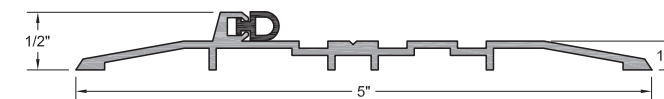
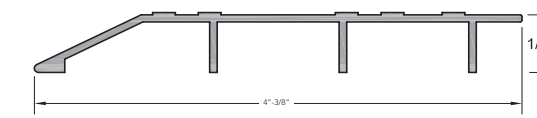
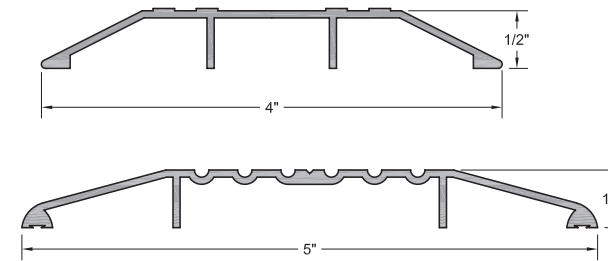
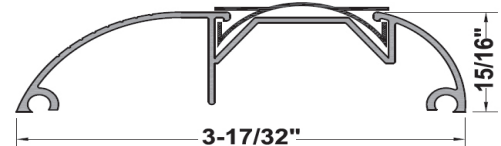

ALUMINUM THRESHOLDS

HANDICAP ACCESSIBLE

ADA APPROVED

Special Order Options

- Special profiles
- Specific lengths
- Jamb notches
- Screw hole punched

Inswing Saddle 1/2"H Mill Finish		
ITEM#	SIZE	QTY BRK
ISHC43612	36-1/2"L x 4"W	10
ISHC36	36"L x 5"W	10
ISHC3612	36-1/2"L x 5"W	10
ISHC73	73"L x 5"W	10

Inswing Tile Back 1/2"H Mill Finish		
ITEM#	SIZE	QTY BRK
ISTB43836	36"L x 4-3/8"W	10

Outswing 1/2"H Mill Finish		
ITEM#	SIZE	QTY BRK
OSHC3612	36-1/2"L x 5"W	10
OSHC36316	36-3/16"L x 5"W	10
OSHC73	73"L x 5"W	10



ALUMINUM THRESHOLDS

ALUMINUM THRESHOLDS

OUTSWING QOSH & QOS (WITH BRONZE WEATHERSTRIP)

Mill or Bronze Finish
Composite Substrate

Special Order Options

Special profiles
Specific lengths
Jamb notches
Screw hole punched (for Tapcons)

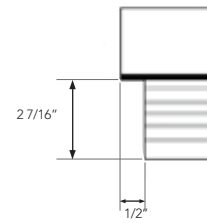

QOS SILLS HAVE
2-7/16" DEPTH
FLUSH NOTCH

4-9/16"W x 1-1/4"H Mill Finish

ITEM#	LENGTH	QTY BRK
QOSH231516FN	23-15/16"	10
QOSH271516FN	27-15/16"	10
QOSH291516FN	29-15/16"	10
QOSH30316FN	30-3/16"	10
QOSH311516FN	31-15/16"	10
QOSH32316FN	32-15/16"	10
QOSH331516FN	33-15/16"	10
QOSH351516FN	35-15/16"	10
QOSH36316FN	36-15/16"	10
QOSH48716FN	48-7/16"	10
QOSH60716FN	60-7/16"	10
QOSH64716FN	64-7/16"	10
QOSH68716FN	68-7/16"	10
QOSH721516FN	72-15/16"	10
QOSH72716FN	72-7/16"	10
QOSH73116FN	73-1/16"	10

4-9/16"W x 1-1/4"H Mill Finish with Holes

ITEM#	LENGTH	QTY BRK
QOSH32FNH	32"	10
QOSH36FNH	36"	10
QOSH73116FNH	73-1/16"	10

4-9/16"W x 1-1/4"H Bronze Finish

ITEM#	LENGTH	QTY BRK
QOSHB36316FN	36-3/16"	10
QOSHB73116FN	73-1/16"	10

4-9/16"W x 1"H Mill Finish

ITEM#	LENGTH	QTY BRK
QOS36316FN	36 3/16"	10
QOS73116FN	73 1/16"	10

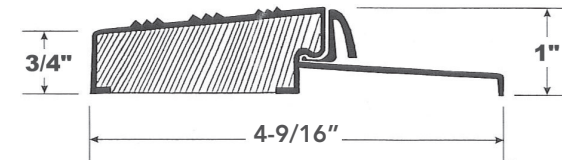
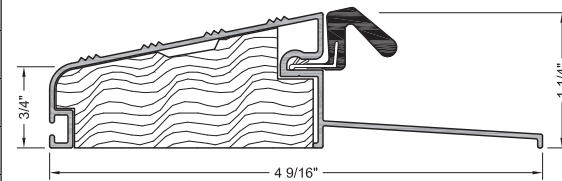

Extenders Mill Finish			
ITEM#	LENGTH	DESCRIPTION	QTY BRK
EXTQOSH136	36"	Converts QOSH Thresholds to 5-1/4" Width	10
EXTQOSH173	73"	Converts QOSH Thresholds to 5-1/4" Width	10
EXTQOSH236	36"	Converts QOSH Thresholds to 6-9/16" Width	10
EXTQOSH273	73"	Converts QOSH Thresholds to 6-9/16" Width	10

Extenders Bronze Finish			
ITEM#	LENGTH	DESCRIPTION	QTY BRK
EXTQOSHB173	73"	Converts QOSH Thresholds to 5-1/4" Width	10
EXTQOSHB273	73"	Converts QOSH Thresholds to 6-9/16" Width	10

Special Order Options
Specific lengths

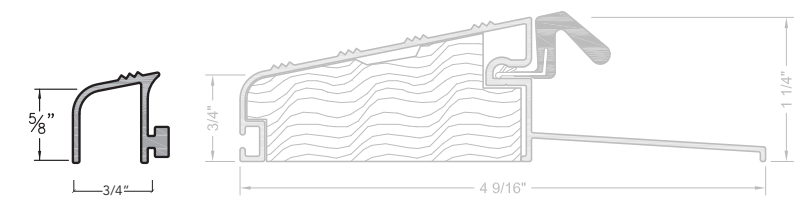

EXTQOSH1 + QOSH

This extends the QOSH series threshold to 5 1/4"

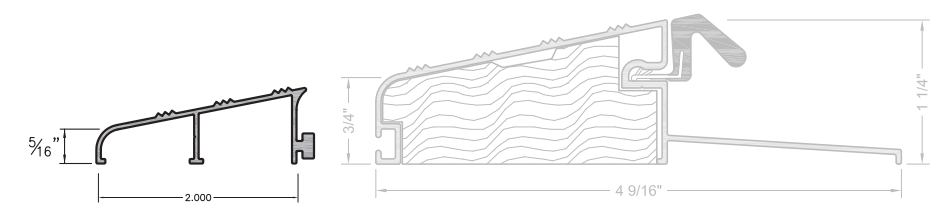

EXTQOSH2 + QOSH

This extends the QOSH series threshold to 6 9/16"

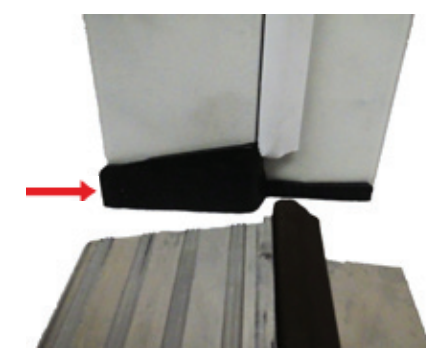

ITEM#	NEW!	DESCRIPTION	MIN QTY
QOSHAJS		Jamb Seal Pair Black For QOSH Thresholds	282

ALUMINUM THRESHOLDS

ALUMINUM THRESHOLDS

OUTSWING QORS (WITH BRONZE WEATHERSTRIP)

Mill or Bronze Finish
Composite substrate

Special Order Options

Special profiles
Specific lengths
Jamb notches
Screw hole punched

*UNLESS OTHERWISE NOTED,
OUTSWING SILLS HAVE 2-7/16
DEPTH FLUSH NOTCH

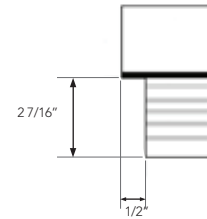

4-9/16"W x 1-3/4"H Mill Finish		
ITEM#	LENGTH	QTY BRK
QOSR231516FN	23-15/16"	10
QOSR291516FN	29-15/16"	10
QOSR311516FN	31-15/16"	10
QOSR351516FN	35-15/16"	10
QOSR36316FN	36-3/16"	10
QOSR60716FN	60-7/16"	10
QOSR64716FN	64-7/16"	10
QOSR72716FN	72-7/16"	10
QOSR73316NN*	73-3/16" No Notch	10
4-9/16"W x 1-3/4"H Bronze Finish		
ITEM#	LENGTH	QTY BRK
QOSR7278BFN	72-7/8"	10

QOSR

1 3/4" high Outswing threshold for use with 4 9/16" jambs.
This threshold eliminates HVHZ water infiltration issues
and works well with marble flooring.

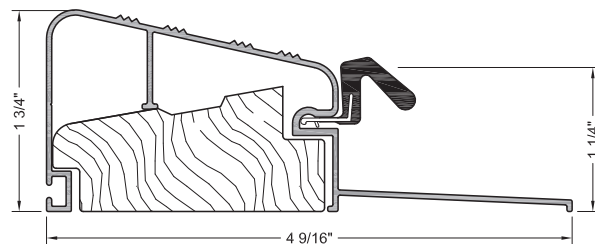

QOSR ACCESSORIES

Extenders Mill Finish			
ITEM#	LENGTH	DESCRIPTION	QTY BRK
EXTQOSR136	36"	Converts QOSR Thresholds to 5-1/4" Width	10
EXTQOSR174	74"	Converts QOSR Thresholds to 5-1/4" Width	10
EXTQOSR236	36"	Converts QOSR Thresholds to 6-9/16" Width	10
EXTQOSR273	73"	Converts QOSR Thresholds to 6-9/16" Width	10
Extenders Bronze Finish			
ITEM#	LENGTH	DESCRIPTION	QTY BRK
EXTQOSR173B	73"	Converts QOSR Thresholds to 5 1/4" Width	10

Special Order Options

Specific lengths

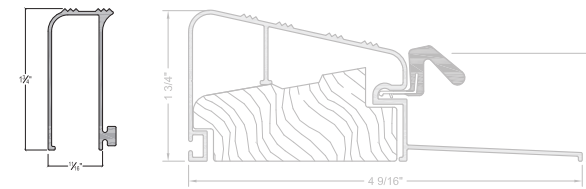

EXTQOSR1+ QOSR

This extends the QOSR series threshold to 5 1/4"

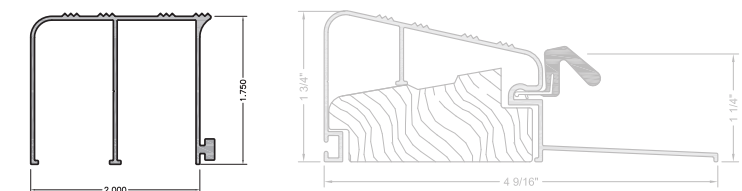

EXTQOSR2+ QOSR

This extends the QOSR series threshold to 6 9/16"

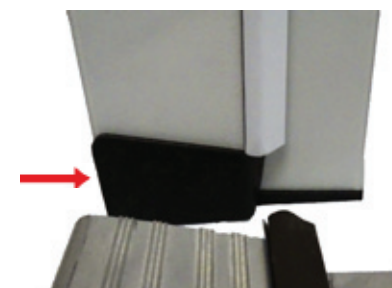

ITEM#	NEW!	DESCRIPTION	MIN QTY
QOSRAJS		Jamb Seal Pair Black For QOSR Thresholds	268

ALUMINUM THRESHOLDS

ALUMINUM THRESHOLDS

INSWING ISCS (adjusts from 1 1/4" up to 1 1/2" high)

4-9/16"W x 1-1/4"H Mill Finish		
ITEM#	LENGTH	QTY BRK
ISCS12	12"	10
ISCS14	14"	10
ISCS231516	23-15/16"	10
ISCS271516	27-15/16"	10
ISCS291516	29-15/16"	10
ISCS311516	31-15/16"	10
ISCS32316	32-3/16"	10
ISCS331516	33-15/16"	10
ISCS351516	35-15/16"	10
ISCS36316	36-3/16"	10
ISCS48716	48-7/16"	10
ISCS56716	56-7/16"	10
ISCS60716	60-7/16"	10
ISCS64716	64-7/16"	10
ISCS68716	68-7/16"	10
ISCS72716	72-7/16"	10
ISCS73116	73-1/16"	10

4-9/16"W x 1-1/4"H Bronze Finish		
ITEM#	LENGTH	QTY BRK
ISCS351516B	35-15/16"	10
ISCS72716B	72-7/16"	10
ISCS73116B	73-1/16"	10

Inswing Covered Seal adjustable threshold for use with 4-9/16" jambs.

Mill or Bronze Finish
Composite substrate
Comes with screw hole plugs

Special Order Options

Special profiles
Specific lengths
Jamb notches
Screw hole punched

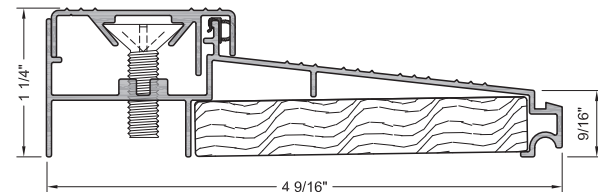

ISW SERIES (adjusts from 1-1/8" up to 1-1/2" high)

5-1/4"W x 1-1/8"H Mill Finish		
ITEM#	LENGTH	QTY BRK
ISW73116	73-1/16"	10

Inswing Covered Seal adjustable threshold for use with 5-1/4" jambs.

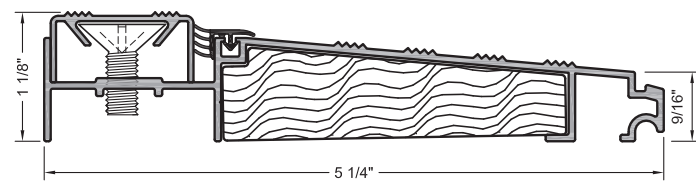

ADDITIONAL MILL INSWINGS

ITEM#	DESCRIPTION	QTY BRK
ISH36316	36-3/16" Inswing Adjustable High	10
ISH73116	73 1/16" Inswing Adjustable High	10
ISWH36	36" Inswing Adjustable High & Wide	10
ISWH72916	72-9/16" Inswing Adjustable High & Wide	10
ISO73116	73-1/16" Inswing Adjustable Oak	10

ISCS ACCESSORIES

ITEM#	LENGTH	DESCRIPTION	FINISH	QTY BRK
EXT173	73"	Converts ISCS Thresholds to 5-1/4" Width	Mill	10
EXT173B	73"	Converts ISCS Thresholds to 5-1/4" Width	Bronze	10
EXT373	73"	Converts ISCS Thresholds to 6-9/16" Width	Mill	10
EXT373B	73"	Converts ISCS Thresholds to 6-9/16" Width	Bronze	10

ISW ACCESSORIES

ITEM#	LENGTH	DESCRIPTION	FINISH	QTY BRK
EXT273	73"	Converts ISW Thresholds to 6-9/16" Width	Mill	10
EXT273B	73"	Converts ISW Thresholds to 6-9/16" Width	Bronze	10
EXT373	73"	Converts ISW Thresholds to 7-1/4" Width	Mill	10
EXT373B	73"	Converts ISW Thresholds to 7-1/4" Width	Bronze	10

ISCS + EXT1

This extends the ISCS series threshold to 5-1/4" width

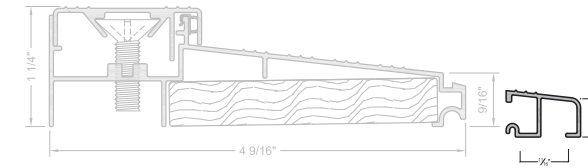

ISW + EXT2

This extends the ISW series threshold to 6-9/16" width

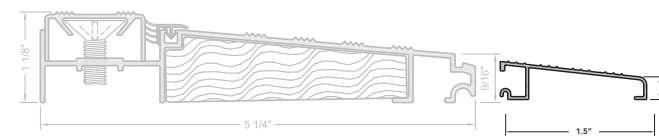

ISW + EXT3

This extends the ISW series threshold to 7-1/4" width

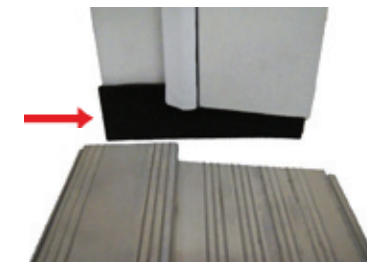
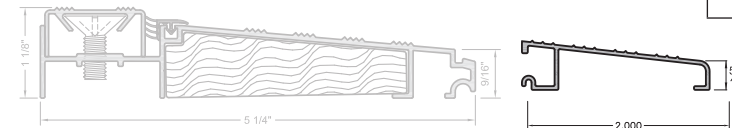

NEW!

ITEM#	DESCRIPTION	MIN QTY
ISCSAJS	Jamb Seal Pair Black For ISCS Thresholds	366



ITEM#	DESCRIPTION	FINISH
140YVT	Tape-Vinyl Threshold	Black

ITEM#	DESCRIPTION	FINISH
ISHPS	Plastic Screw Hole Plugs for Inswing Thresholds	Mill

ITEM#	DESCRIPTION	FINISH	QTY BRK
ISSLBW12	11-15/16" Inswing Sidelite Boot	White	10
ISSLBW36	35-15/16" Inswing Sidelite Boot	White	10



WEATHER SEALS

WEATHER SEALS

Weather seals

When it comes to keeping the good weather in and the bad weather out, our Weather Seals are the Real Deal. Both our short reach and long reach weatherstripping types are designed to stand the test of time in harsh environments. We also offer the best in door sweep options. All of our kerf door seals are designed to install into jamb kerfs perfectly – not too tight – not too loose.

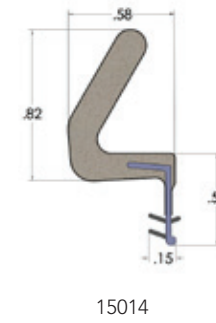
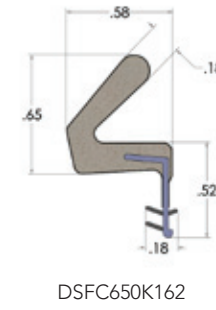
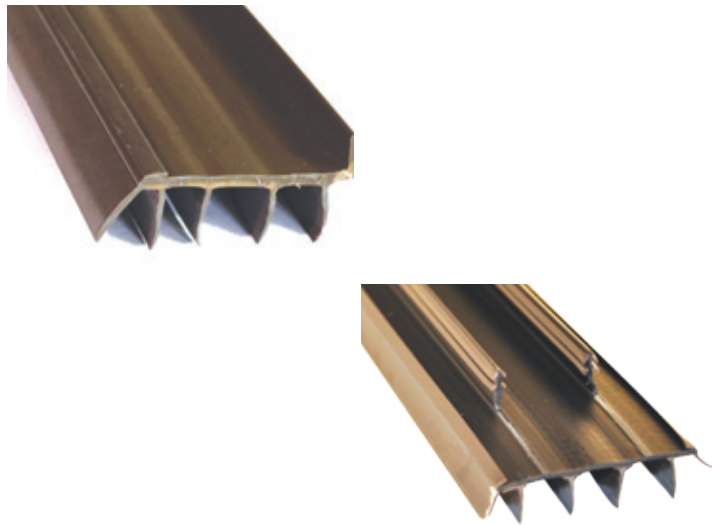

WEATHERSTRIP

.650 Reach Kerfed			
ITEM#	LENGTH	FINISH	MIN QTY
DSFC650K16282WH	82"	White	150
DSFC650K16282BZ	82"	Bronze	150
DSFC650K16297WH	97"	White	150
DSFC650K16297BZ	97"	Bronze	150
.825 Long Reach Kerfed			
150149	97"	White	125
150148	97"	Bronze	125

CORNER SEALS

ITEM#	DESCRIPTION	FINISH	MIN QTY
CSADH1688WH	2" Corner Seal	White	2000
CSADH1688BRZ	2" Corner Seal	Bronze	2000
SSCORNERPADWH	Simple Solution Corner Pad (2 Pack)	White	50
SSCORNERPADBR	Simple Solution Corner Pad (2 Pack)	Bronze	50

JAMB SEALS PAIRS BLACK

NEW!

ITEM#	DESCRIPTION	MIN QTY
QOSHAJS	For QOSH Thresholds	282
QOSRAJS	For QOSR Thresholds	268
ISCSAJS	For ISCS Thresholds	366

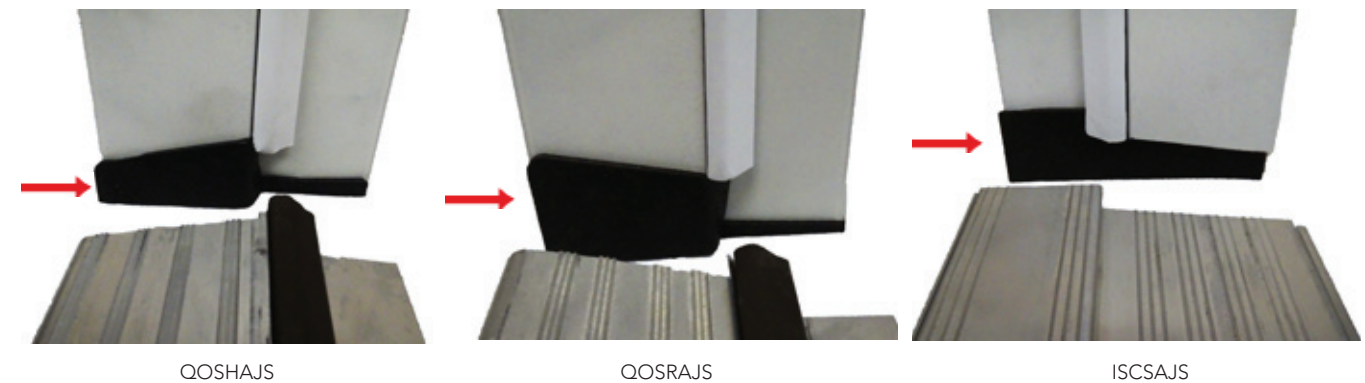

WEATHER SEALS

WEATHER SEALS

DOOR SWEEPS

WRAP ADJUSTABLE DOOR SWEEP

ITEM#	LENGTH	FINISH	MIN QTY
WTV02380WH037	37"	White	24
WTV02380CB037	37"	Bronze	24

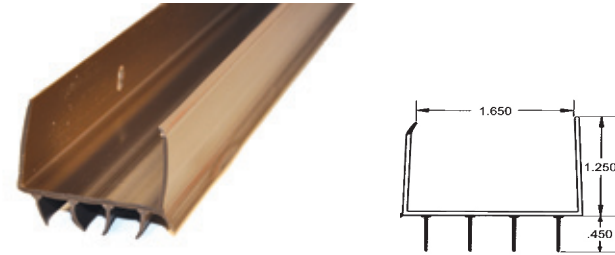

7/8" Top seal application

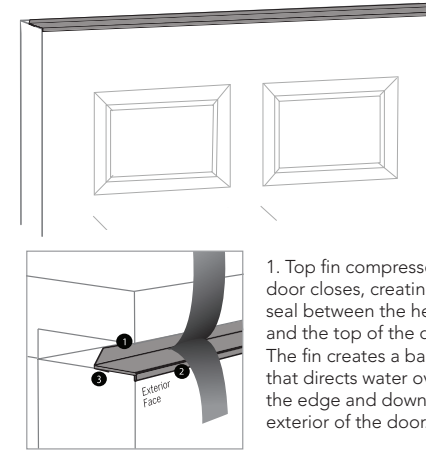

TOP SEAL BRONZE

ITEM#	DESCRIPTION	MIN QTY
DTBR30	36" for Outswing Doors	25

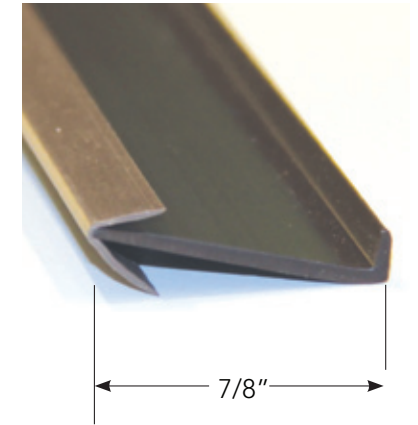

SCREW/STAPLE DOOR SWEEP BRONZE

ITEM#	LENGTH	MIN QTY
WTV03871CB037	36"	50
WTV03871CB048	48"	50

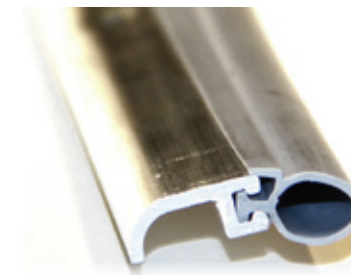
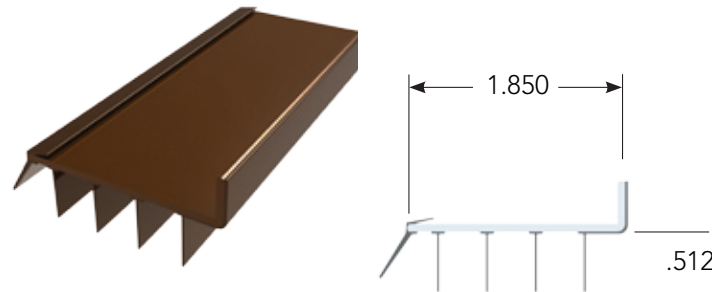

OTHER DOOR SEALS

ITEM#	DESCRIPTION	FINISH
JAMBUP17	17' Aluminum & Vinyl Weatherstrip	Mill/ Grey

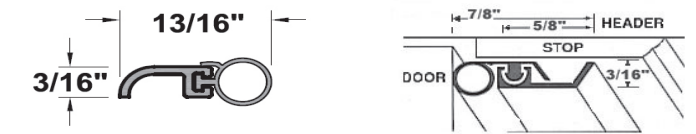

PRESSURE FIT DOOR SWEEP BRONZE

ITEM#	LENGTH	MIN QTY
WTV03122DK03575	35-3/4"	100
WTV01996CB030X4	29-3/4"	100
WTV01996CB032X4	31-3/4"	100
WTV01996CB036X4	35-3/4"	100

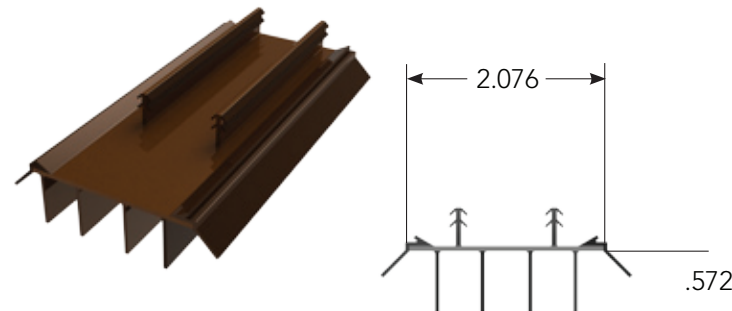

ITEM#	DESCRIPTION	FINISH
BULKBUG36	36" Bug Sweep (Bulk Pack)	Mill

DOOR HINGES

DOOR HINGES

Exterior & Interior Hinges

One of the most vital parts of any quality Pre-Hung Door System is the door hinge. No door unit is complete without them. A lot of weight can ride on these components for long periods of time (especially when hanging Impact product), so quality hinges are an absolute necessity.

Managing a supply chain for hinges is no easy feat. Getting well-built hinges at competitive prices often requires import purchases at very high volumes.

We offer the best-in-class hinges in durable stainless steel, as well as most other popular U.S. finishes. We also offer many finishes in both standard bearing and ball bearing versions. All our exterior hinges come with security features (Studs or Non-Removable Pins). We even offer Spring Hinges for increased ease of use.



LEFT HAND



RIGHT HAND

RESIDENTIAL EXTERIOR

See color chart page 49.

All Hinges on this page come packaged with wood screws.

4"x4" 5/8" RADIUS SECURITY

ITEM#	SECURITY	FINISH	QTY BRK
42D58STUD	Safety Stud	Zinc	100 / 500
4P58STUD	Safety Stud	Primed	100 / 500
426D58STUD	Safety Stud	Satin Chrome	100 / 500
41558STUD	Safety Stud	Brushed Satin Nickel	100 / 500
415S58STUD	Safety Stud	Smooth Satin Nickel	100 / 500
410B58STUD	Safety Stud	Satin Bronze	100 / 500
432D58STUD	Safety Stud	Stainless Steel	100 / 500
4US358STUD	Safety Stud	Bright Brass	100 / 500
415A58STUD	Safety Stud	Antique Nickel	100 / 500
4558NRP	Non-Removable Pin	Antique Brass	100 / 500

4"x4" 5/8" RADIUS x SQUARE SECURITY

ITEM#	DESCRIPTION	FINISH	QTY BRK
42D58SQSTUDL	Safety Stud Left Handed	Zinc	100 / 500
42D58SQSTUDR	Safety Stud Right Handed	Zinc	100 / 500
41558SQSTUDL	Safety Stud Left Handed	Brushed Satin Nickel	100 / 500
41558SQSTUDR	Safety Stud Right Handed	Brushed Satin Nickel	100 / 500
410B58SQSTUDL	Safety Stud Left Handed	Satin Bronze	100 / 500
410B58SQSTUDR	Safety Stud Right Handed	Satin Bronze	100 / 500
432D58SQSTUDL	Safety Stud Left Handed	Stainless Steel	100 / 500
432D58SQSTUDR	Safety Stud Right Handed	Stainless Steel	100 / 500
4US358SQSTUDR	Safety Stud- Right Hand	Bright Brass	100 / 500
4US358SQSTUDL	Safety Stud- Right Hand	Bright Brass	100 / 500
CAS44L26DNRP	Left Handed Non-Removable Pin	Dull Chrome	100 / 500
CAS44R26DNRP	Right Handed Non-Removable Pin	Dull Chrome	100 / 500

DULL CHROME US26D	ZINC DICHROMATE US2D	SMOOTH SATIN NICKEL US15S	ANTIQUÉ BRASS US5	STAIN-LESS STEEL US32D	ANTIQUÉ NICKEL US15A	PRIMED WHITE USPP	BRUSHED SATIN NICKEL US15	BRIGHT BRASS US3	SATIN BRONZE US10C	MATTE BLACK US19

Color chart for representation only.

DOOR HINGES

DOOR HINGES

RESIDENTIAL EXTERIOR

See color chart page 49.

All Hinges on this page come packaged with wood screws.

BALL-BEARING 4"x4" 5/8" RADIUS x SQUARE SAFETY STUD

ITEM#	FINISH	QTY BRK
BB42D58STUD	Zinc	100 / 500
BB410B58STUD	Satin Bronze	100 / 500
BB432D58STUD	Stainless Steel	100 / 500
BBRH401NRP	Black	100 / 500

BALL-BEARING 4"x4" 5/8" RADIUS x SQUARE SAFETY STUD

ITEM#	DESCRIPTION	FINISH	QTY BRK
BB432D58SQSTUDL	Left Handed	Stainless Steel	100 / 500
BB432D58SQSTUDR	Right Handed	Stainless Steel	100 / 500
BB42D58SQSTUDL	Left Handed	Zinc	100 / 500
BB42D58SQSTUDR	Right Handed	Zinc	100 / 500



LEFT HAND RIGHT HAND

The Spring Hinges below also come packaged with adjustment tools and pins.

SPRING 4"x4" 5/8" RADIUS

ITEM#	FINISH	QTY BRK
SP410B58	Satin Bronze	80
SP415S58	Smooth Satin Nickel	80

SPRING 4"x4" 5/8" RADIUS x SQUARE

ITEM#	FINISH	QTY BRK
SP410B58SQL	Oil Rubbed Bronze	80
SP410B58SQR	Oil Rubbed Bronze	80
SP415S58SQL	Smooth Satin Nickel	80
SP4P58SQL	Primed	50



RESIDENTIAL INTERIOR

See color chart page 49.

All Hinges on this page come packaged with wood screws.

3-1/2"x3-1/2" 5/8" RADIUS

ITEM#	FINISH	QTY BRK
3122D58	Zinc	100 / 500
312P58	Primed	100 / 500
312US358	Bright Brass	100 / 500
312558	Antique Brass	100 / 500
31226D58	Satin Chrome	100 / 500
31215A58	Antique Nickel	100 / 500
3121558	Brushed Satin Nickel	100 / 500
31210B58	Satin Bronze	100 / 500
3122658	Bright Chrome	100 / 500
3123LB58	Brushed Brass	100 / 500

SPRING 3-1/2"x3-1/2" 5/8" RADIUS

The Spring Hinges below also come packaged with adjustment tools and pins.

ITEM#	FINISH	QTY BRK
SP31215S58	Smooth Satin Nickel	100 / 1000

RESIDENTIAL HINGE SCREWS 3/4" x #9

ITEM#	FINISH	QTY BRK
SCREWSUS3	Bright Brass	600
SCREWSUS10B	Oil Rubbed Bronze	800
SCREWSUS15	Satin Nickel	600
SCREWSUS15A	Antique Nickel	600
SCREWSUSPP	Primed	800
SCREWSUS32D	Stainless Steel	800

Other finishes available while supplies last: Zinc, Satin Chrome

COMMERCIAL 4.5" x 4.5"

Commercial Hinges also come packaged with machine screws.

ITEM#	DESCRIPTION	FINISH	QTY BRK
SP41226D	Spring Hinge Square Corner*	Satin Chrome	48
TB41226DNRP	Ball Bearing Template Hinge	Satin Chrome	48
TB41232DNRP	Ball Bearing Template Hinge	Stainless Steel	48
ITEM#	DESCRIPTION	FINISH	MIN QTY
TB412US10BNRP	Ball Bearing Template Hinge	Oil Rubbed Bronze	3
T41232D	Template Hinge	Stainless Steel	3
T412DCH	Template Hinge	Satin Chrome	3

*Commercial Spring hinges will also include adjustment tools and pins.

MULTI-POINT SECURITY HARDWARE



The New Generation of Multi-point Locks.

PanoLock offers all the strength and security of a traditional multi-point locking system, with a few added advantages.

- Special adapters allow the use of most off-the-shelf trim sets. No dedicated hardware required.
- Two of the three locking points are tapered to enhance performance while reducing the amount of force needed for operation.
- Stocked in two sizes: 6/8 and 8/0.
- Stocked in two finishes: Bronze and Clear Anodized.
- Works with any stocked Yale or Pamex Handlesets.
- Works with all stocked Deadbolts except Electronic Deadbolts.
- Works with all stocked Leversets and Knobsets except Yale Heritage (YH) and Real Living Series.

Life is full of changes, and that includes your style. With PanoLock, you can change your door handlesets as often as you change your mind. Whether you prefer a sleek and modern leverset with a matte black finish or a traditional gripset in satin nickel finish, PanoLock is designed to fit your style and your choice of hardware.



INTERNAL MECHANISMS WITH FACEPLATES

Mechanisms come packaged with installation hardware.

1000 Series Inswing		
ITEM#	DESCRIPTION	FINISH
PL1000CL68LISBNP	6/8 Left Handed	Brushed Clear Anodized
PL1000CL68RISBNP	6/8 Right Handed	Brushed Clear Anodized
PL1000CL80LISBNP	8/0 Left Handed	Brushed Clear Anodized
PL1000CL80RISBNP	8/0 Right Handed	Brushed Clear Anodized
PL1000BZ68LISBNP	6/8 Left Handed	Bronze Anodized
PL1000BZ68RISBNP	6/8 Right Handed	Bronze Anodized
PL1000BZ80LISBNP	8/0 Left Handed	Bronze Anodized
PL1000BZ80RISBNP	8/0 Right Handed	Bronze Anodized

PARTS & ACCESSORIES

ITEM#	DESCRIPTION	FINISH
PCSTRKPK175SS	Strike Kit for 1-3/4" Door (3 strikes with screws)	Stainless Steel
PCSTRKPK175BK	Strike Kit for 1-3/4" Door (3 strikes with screws)	Black
PCSTRKPK225SS	Strike Kit for 2-1/4" Door (3 strikes with screws)	Stainless Steel
PCREINSDUST50	Reinforcing Roller Strike & Dust Box Kit (3 plates)	Mill/ Black
PLCNSTRCTHNDL25	Construction Handel	Mill



PCSTRKPK175



PCSTRKPK225



PLCNSTRCTHNDL25



PCREINSDUST50

PanoLock is compatible with most off-the-shelf hardware brands. Use almost any knob, lever, or handle set from your favorite manufacturer!

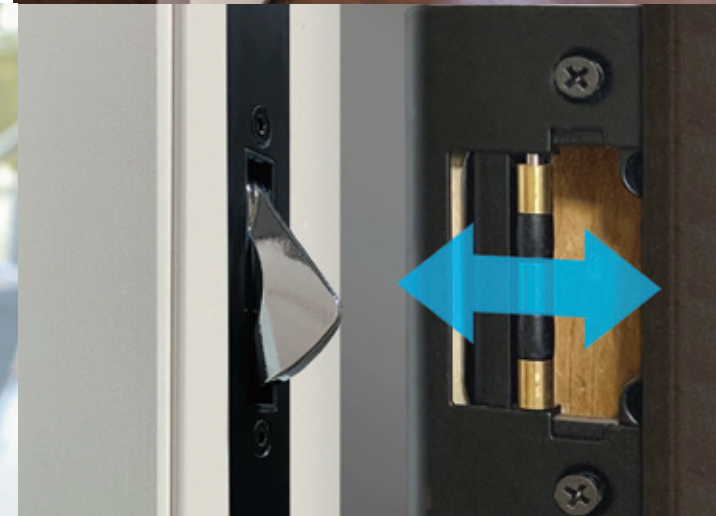

MULTI-POINT SECURITY HARDWARE

TRILENNIUM™ Multi-Point Locking System

Security. Strength. Reliability. Performance.

Unmatched security doesn't have to mean compromised style. Trilennium offers a growing portfolio of attractive handset designs that work in conjunction with a locking mechanism which installs into a router carved pocket in the edge of your door. This mechanism features one solid unit with three latches based on patented I-Beam construction for reliable, proven strength and performance. Operating as one unit, all three latches engage when the door is closed. One movement of the thumb-turn or key turn activates all three deadbolts. Each latch is a deadbolt which adds increased protection for any entryway.

- Patented Strike Rollers and latches draw the door panel into perfect alignment with the jamb for a tight seal with no deflection
- A single downward turn of the interior handle releases all three deadbolts making it panic-proof
- Keying available; Our Stock has a SCHLAGE C Keyway, and can be keyed to Yale locks for whole house compatibility. Also available in Smart Key!
- Manufactured in the USA



ECLIPSE SHOWN IN SATIN NICKEL

See pg. 56 for Trilennium dedicated trim hardware. Our stocks leversets specifically designed to work with this system.



MULTI-POINT SECURITY HARDWARE

INTERNAL MECHANISMS WITH STAINLESS STEEL FACEPLATES

Mechanisms come packaged with installation hardware.

ITEM#	DESCRIPTION
TL3000SS68RISBNP	6/8 & 7/0 Right Hand
TL3000SS68LISBNP	6/8 & 7/0 Left Hand
TL3000SS80RISBNP	8/0 Right Hand
TL3000SS80LISBNP	8/0 Left Hand

PARTS & ACCESSORIES

ITEM#	DESCRIPTION	FINISH
TCSTRKPKC225SS	Strike Kit for 2-1/4" Door (3 strikes with screws)	Stainless Steel
TCSTRKPKC175SS	Strike Kit for 1-3/4" Door (3 strikes with screws)	Stainless Steel
TCSTRKPKC3WDSS	Strike Kit for 1-3/4" Astragal (3 strikes with screws)	Stainless Steel
TCREINFPLATKIT50	Reinforcing Roller Strike Kit (3 plates)	Stainless Steel
TCEXTARMKIT	Exterior Link Arm Kit	Stainless Steel
TCDUSTBOX100	Plastic Dust Box	Black
TCCNSTRCTHNDL175	Construction Handle (with screws)	Aluminum



TCREINFPLATKIT50



TCCNSTRCTHNDL175

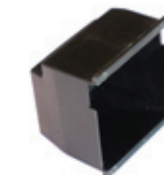

TCDUSTBOX100

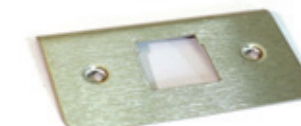

TCSTRKPKC3WDSS

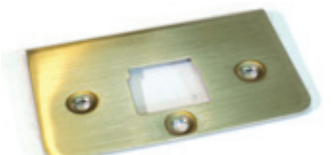

TCSTRKPKC225SS



TCKEYCYLS175PC

KEYS & CYLINDERS

ITEM#	DESCRIPTION	FINISH
TCKEYBLANKW	Weiser Key Blanks	Nickel
TCKEYCYLS175PC	Schlage "C" Key Cylinder	Satin Chrome

Keying available; Our stock have Weiser Keyway cylinders. Also available with Schlage C Keyway or Smart Key

MULTI-POINT SECURITY HARDWARE

SECURITY HARDWARE

TRILENNIUM™ Multi-Point Locking System

All Trims come packaged with installation hardware.

ECLIPSE LEVERSET TRIMS

ITEM#	DESCRIPTION	FINISH
ECPLACTSN175NW	Active	Satin Nickel
ECPLACTVB175NW	Active	Victorian Bronze
ECPLDUMSN175N	Dummy	Victorian Bronze



PINNACLE LEVERSET TRIMS

ITEM#	DESCRIPTION	FINISH
PINLACTSN175NW	Active	Satin Nickel
PINLACTVB175NW	Active	Victorian Bronze



HORIZON LEVERSET TRIMS

ITEM#	DESCRIPTION	FINISH
HORLACTSN175NW	Active	Satin Nickel



RECTANGULAR LEVERSET TRIMS

ITEM#	DESCRIPTION	FINISH
RECLACTSN175NW	Active	Satin Nickel
RECLACTVB175NW	Active	Victorian Bronze
RECLACTBK175NW	Active	Black



TOUCHSCREEN
DEADBOLT
YRD226



TOUCHSCREEN
DEADBOLT
INSIDE VIEW



TOUCHSCREEN
LEVER
YRD226
(Special Order)

PUSH BUTTON
LEVER
INSIDE VIEW
(Special Order)

Residential & Light-Commercial Locksets

Yale Residential Securies offer a complete range of lockset styles and finishes perfectly suited to complete your door system. Combining years of engineering refinement with fine craftsmanship, Yale continues the high standards set forth by Linus Yale in the mid-19th century. These collections of locksets offer superior functionality, easy installation, and secure performance.

All Yale Locksets come packaged with installation hardware.

ASSURE TOUCHSCREEN DEADBOLTS

Our stocks Touchscreen Deadbolts with no Radio Communication Modules installed in them. Deadbolts with various module options can be Special Ordered though QuickShip (Z-Wave/ Zigbee, Yale Access).

ITEM#	FINISH
YRD226US15NR	Satin Nickel
YRD226US10BPNR	Oil Rubbed Bronze

Keying available; Our stock have Weiser Keyway cylinders. Also available with Schlage C Keyway or Smart Key.

All locks can be keyed alike or master keyed at your request.

SECURITY HARDWARE

SECURITY HARDWARE

HERITAGE LOCKSETS

Prestige, strength, and longevity. Residential and light-commercial locksets in a wide range of exciting designs at surprisingly affordable prices. All YH Series latches are Round Corner Adjustable latches. Unless otherwise specified, all key cylinders are KW-1.

(ANSI Grade 2)

All Yale Locksets come packaged with installation hardware.

Jamestown Handlesets (trim not included)		
ITEM#	DESCRIPTION	FINISH
927JUS15LIP	Single Cylinder Entry	Satin Nickel
927JUS10BPLIP	Single Cylinder Entry	Oil Rubbed Bronze
927JUS3LIP	Single Cylinder Entry	Bright Brass

Homestead Handlesets (trim not included)		
ITEM#	DESCRIPTION	FINISH
926HUS15LIP	Single Cylinder Entry	Satin Nickel
926HUS10BPLIP	Single Cylinder Entry	Oil Rubbed Bronze
926HUS3LIP	Single Cylinder Entry	Bright Brass

McClure Leversets		
ITEM#	DESCRIPTION	FINISH
71MCUS15	Entry	Satin Nickel
71MCUS10BP	Entry	Oil Rubbed Bronze
71MCUS3	Entry	Bright Brass

Norwood Leversets		
ITEM#	DESCRIPTION	FINISH
11NWUS15	Passage	Satin Nickel
71NWUS15	Entry	Satin Nickel
71NWUS10BP	Entry	Oil Rubbed Bronze
81NWUS15LH	Dummy	Satin Nickel
81NWUS15RH	Dummy	Satin Nickel
720NWUS15LH	Inner Trim Pack	Satin Nickel
720NWUS15RH	Inner Trim Pack	Satin Nickel
720NWUS10BPLH	Inner Trim Pack	Oil Rubbed Bronze
720NWUS10BPRH	Inner Trim Pack	Oil Rubbed Bronze
720NWUS3RH	Inner Trim Pack	Bright Brass
720NWUS15ALH	Inner Trim Pack	Antique Nickel

All locks can be keyed alike or master keyed at your request.



JAMESTOWN HOMESTEAD



MCCLURE



NORWOOD



VALDOSTA



AUGUSTA



CAMBRIDGE



DARTMOUTH



DEADBOLT
UL Available



Schlage replacement key cylinders are available by Special Order

All Yale Locksets come packaged with installation hardware.

Valdosta Leverset		
ITEM#	DESCRIPTION	FINISH
71VLUS15	Entry	Satin Nickel

Augusta Leverset		
ITEM#	DESCRIPTION	FINISH
71AUUS15	Entry	Satin Nickel

Cambridge Knobsets		
ITEM#	DESCRIPTION	FINISH
70CBUS15	Entry	Satin Nickel
70CBUS10BP	Entry	Oil Rubbed Bronze
720CBUS15	Inner Trim Pack	Satin Nickel
720CBUS10BP	Inner Trim Pack	Oil Rubbed Bronze

Dartmouth Knobset		
ITEM#	DESCRIPTION	FINISH
70DMUS15	Entry	Satin Nickel

Select Deadbolt		
ITEM#	DESCRIPTION	FINISH
83SDBUS15	Single Cylinder	Satin Nickel
83SDBUS10BP	Single Cylinder	Oil Rubbed Bronze
83SDBUS26D	Single Cylinder	Satin Chrome

Premier Deadbolt (U.L.Listed with Schlage Key Cylinder)		
ITEM#	DESCRIPTION	FINISH
82PDBUS26DSCH	Single Cylinder	Satin Chrome

Deadbolt Security Strike (HVHZ)	
ITEM#	FINISH
YR02081US26	Bright Chrome
YR02081BLACK	Black

SECURITY HARDWARE

SECURITY HARDWARE

NEW TRADITIONS LOCKSETS

Standard-duty residential locksets with enhanced quality, durability, and style features. All New Traditions Series latches are Round Corner Adjustable latches. Unless otherwise specified, all key cylinders are KW-1.

(ANSI Grade 3)

All Yale Locksets come packaged with installation hardware.

McKinley Handlesets (trim not included)

ITEM#	DESCRIPTION	FINISH
622MUS15LIP	Single Cylinder Entry	Satin Nickel
622MUS10BPLIP	Single Cylinder Entry	Oil Rubbed Bronze
622MUS3LIP	Single Cylinder Entry	Bright Brass
622MUS5LIP	Single Cylinder Entry	Antique Brass

Rainier Handlesets (trim not included)

ITEM#	DESCRIPTION	FINISH
623RUS15LIP	Single Cylinder Entry	Satin Nickel
623RUS10BPLIP	Single Cylinder Entry	Oil Rubbed Bronze

Teton Handleset (trim not included)

ITEM#	DESCRIPTION	FINISH
621TUS15LIP	Single Cylinder Entry	Satin Nickel

Woodland Leversets

ITEM#	DESCRIPTION	FINISH
101WLUS15	Passage	Satin Nickel
771WLUS15	Entry	Satin Nickel
771WLUS10BP	Entry	Oil Rubbed Bronze
620WLUS15	Inner Trim Pack	Satin Nickel
620WLUS10BP	Inner Trim Pack	Oil Rubbed Bronze

All locks can be keyed alike or master keyed at your request.



CIRRUS



SAVANNAH



HORIZON



DEADBOLT

All Yale Locksets come packaged with installation hardware.

Cirrus Knobsets

ITEM#	DESCRIPTION	FINISH
100CUS15	Passage	Satin Nickel
100CUS26D	Passage	Satin Chrome
200CUS15	Privacy	Satin Nickel
200CUS26D	Privacy	Satin Chrome
700CUS15	Entry	Satin Nickel
700CUS10BP	Entry	Oil Rubbed Bronze
700CUS26D	Entry	Satin Chrome
620CUS15	Inner Trim Pack	Satin Nickel
620CUS10BP	Inner Trim Pack	Oil Rubbed Bronze

Savannah Leversets

ITEM#	DESCRIPTION	FINISH
101SLUS15	Passage	Satin Nickel
771SLUS15	Entry	Satin Nickel
620SLUS15LH	Left Hand Inner Trim Pack	Satin Nickel
620SLUS15RH	Right Hand Inner Trim Pack	Satin Nickel
620SLUS3RH	Right Hand Inner Trim Pack	Bright Brass

Horizon Knobsets

ITEM#	DESCRIPTION	FINISH
700HUS15	Entry	Satin Nickel
700HUS26D	Entry	Satin Chrome

800 Series Deadbolts

ITEM#	DESCRIPTION	FINISH
820US15	Single Cylinder	Satin Nickel
820US10BP	Single Cylinder	Oil Rubbed Bronze
820US3	Single Cylinder	Bright Brass
820US5	Single Cylinder	Antique Brass
820US15A	Single Cylinder	Antique Nickel
820US26D	Single Cylinder	Satin Chrome
840US15	Double Cylinder	Satin Nickel

SECURITY HARDWARE

SECURITY HARDWARE

EDGE LOCKSETS

Budget friendly residential locksets with Round Corner Adjustable latches. Unless otherwise specified, all key cylinders are KW-1.

(ANSI Grade 3)

All Yale Locksets come packaged with installation hardware.

Lenoir Handsets (trim not included)		
ITEM#	DESCRIPTION	FINISH
927LNUS15	Single Cylinder Entry	Satin Nickel
927LNUS10BP	Single Cylinder Entry	Oil Rubbed Bronze

Alpharetta Leverset		
ITEM#	DESCRIPTION	FINISH
71ALUS15	Entry	Satin Nickel

Keowee Leversets		
ITEM#	DESCRIPTION	FINISH
11KWUS15	Passage	Satin Nickel
11KWUS10BP	Passage	Oil Rubbed Bronze
21KWUS15	Privacy	Satin Nickel
21KWUS10BP	Privacy	Oil Rubbed Bronze
71KWUS15	Entry	Satin Nickel
71KWUS10BP	Entry	Oil Rubbed Bronze
81KWUS15LH	Left Hand Dummy	Satin Nickel
81KWUS15RH	Right Hand Dummy	Satin Nickel
81KWUS10BPLH	Left Hand Dummy	Oil Rubbed Bronze
KWTRIMUS15LH	Left Hand Inner Trim	Satin Nickel
KWTRIMUS15RH	Right Hand Inner Trim	Satin Nickel
KWTRIMUS10BPLH	Left Hand Inner Trim	Oil Rubbed Bronze

Edge Series Deadbolts		
ITEM#	DESCRIPTION	FINISH
82EUS15	Single Cylinder	Satin Nickel
82EUS10BP	Single Cylinder	Oil Rubbed Bronze

Athens Combo Pack		
ITEM#	DESCRIPTION	FINISH
837ATUS32D	Entry Knob & Single Cylinder Deadbolt	Stainless Steel

All locks can be keyed alike or master keyed at your request.



PAMEX LOCKSETS

All Pamex Locksets come packaged with installation hardware.

The Kapture Series electronic deadbolts come standard with Bluetooth to communicate directly with the Kapture app on a mobile device. They can also be upgraded with a WiFi bridge to allow them to communicate with home automation systems.

(ANSI Grade 2)

Kapture Smart Lock		
ITEM#	DESCRIPTION	FINISH
KP1-D7P1	Touchscreen Deadbolt	Satin Nickel
KP1-D791	Touchscreen Deadbolt	Matte Black
KP1-LINK	WiFi Bridge	White

Deadbolt Security Strike (HVHZ)	
ITEM#	FINISH
YR02081US26	Bright Chrome
YR02081BLACK	Black

(ANSI Grade 2)

Tuscany Handlesets (with Baron Knob Trim Pack included)		
ITEM#	DESCRIPTION	FINISH
FSTPF1	Single Cylinder Entry	Satin Nickel
FSTOF1	Single Cylinder Entry	Oil Rubbed Bronze
FSTPF4	Dummy	Satin Nickel
FSTOF4	Dummy	Oil Rubbed Bronze

(ANSI Grade 3)

Alto Leversets		
ITEM#	DESCRIPTION	FINISH
FLFP03	Passage	Satin Nickel
FLF903	Passage	Matte Black
FLFP08C	A.D.A. Privacy	Satin Nickel
FLF908C	A.D.A. Privacy	Matte Black

SECURITY HARDWARE

COMMERCIAL DOOR HARDWARE

PAMEX LOCKSETS

All Pamex Locksets come packaged with installation hardware.

Onyx Leversets		
ITEM#	DESCRIPTION	FINISH
FLSP03C	Passage	Satin Nickel
FLS903C	Passage	Matte Black
FLSP08C	A.D.A. Privacy	Satin Nickel
FLS908C	A.D.A. Privacy	Matte Black
FLSP04	Dummy	Satin Nickel
FLS904	Dummy	Matte Black

Mira Leversets		
ITEM#	DESCRIPTION	FINISH
FLTP03C	Passage	Satin Nickel
FLT903C	Passage	Matte Black
FLTP08C	A.D.A. Privacy	Satin Nickel
FLT908C	A.D.A. Privacy	Matte Black
FLTP04	Dummy	Satin Nickel
FLT904	Dummy	Matte Black

Olympic Leversets		
ITEM#	DESCRIPTION	FINISH
FLG603	Passage	Satin Nickel
FLG903	Passage	Matte Black
FLG608C	A.D.A. Privacy	Satin Nickel
FLG908C	A.D.A. Privacy	Matte Black

FD2 Standard Deadbolt		
ITEM#	DESCRIPTION	FINISH
FD291	Single Cylinder	Matte Black
FD2P1	Single Cylinder	Satin Nickel

FDK Rounded Deadbolt		
ITEM#	DESCRIPTION	FINISH
FDK91	Single Cylinder	Matte Black
FDKP1	Single Cylinder	Satin Nickel

FDS Squared Deadbolt		
ITEM#	DESCRIPTION	FINISH
FDS91	Single Cylinder	Matte Black
FDSP1	Single Cylinder	Satin Nickel

Keying Kits	
ITEM#	DESCRIPTION
FKK-KW	KW KEYWAYS
FKK-SC	SC KEYWAYS



ONYX



MIRA



OLYMPIC



FD2 SERIES



FDK SERIES



FDS SERIES

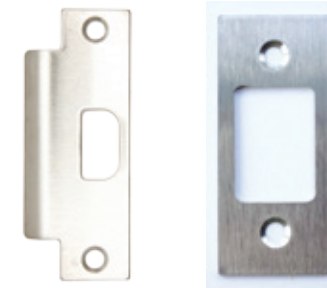

Strikes Satin Chrome		
ITEM#	SIZE	DESCRIPTION
ASAST26D	1-1/4" x 4-7/8"	ANSI ASA T-Strike
TA013US26D	1-1/8" x 2-3/4"	T-Strike
TA019CMD	1-1/8" x 2-3/4"	Universal Deadbolt Strike



Door Closers Aluminum Finish	
ITEM#	DESCRIPTION
1101BF569	Size 1-4 (cover and sex bolts not included)
706	Male Sex Bolt for 1101 Closer (4pk)
970AL	Female Sleeve for 1101 Closer (4pk)
GC5900BF-AL	Size 1-6 (cover and sex bolts included)



Panic Hardware		
ITEM#	DESCRIPTION	FINISH
5000EO36AL	Panic Device	Aluminum
8000L26D	Panic Lever Entry Trim	Satin Chrome



Kick Plate		
ITEM#	SIZE	FINISH
KPAL828	8" x 28"	Aluminum



Push/ Pull Plates			
ITEM#	DESCRIPTION	FINISH	QTY BRK
5310US32D	Pull	Stainless Steel	10
53US32D	Push	Stainless Steel	10

All items on this page come packaged with installation hardware.

Cylindrical Leversets Schlage Keyway Satin Chrome	
ITEM#	DESCRIPTION
4602LN626AU	Augusta Privacy
SL00US26D	SL Entry
SSLD-23826D	Deadlatch for Cylindrical Lock

HOUSE NUMBERS

HOUSE NUMBERS

ADDRESS SIGNS **NEW!**

Silver metallic textured house numbers that can be mounted on your choice of Bronze or Matte Black sign bases. The bases come in 3, 4, or 5 digit varieties. Both bases and numbers come packaged with screws.

20" x 7" Textured Sign Bases		
ITEM#	DESCRIPTION	FINISH
6012B3C-BZ	3 Digit	Bronze
6012B3C-MB	3 Digit	Matte Black
6012B4C-BZ	4 Digit	Bronze
6012B4C-MB	4 Digit	Matte Black
6012B5C-BZ	5 Digit	Bronze
6012B5C-MB	5 Digit	Matte Black
6" Aluminum Raised House Numbers		
ITEM#	DESCRIPTION	FINISH
6012N0-1	"0"	Silver
6012N1-1	"1"	Silver
6012N2-1	"2"	Silver
6012N3-1	"3"	Silver
6012N4-1	"4"	Silver
6012N5-1	"5"	Silver
6012N6-1	"6"	Silver
6012N7-1	"7"	Silver
6012N8-1	"8"	Silver
6012N9-1	"9"	Silver



6" HEAVY DUTY SURFACE MOUNT **NEW!**

The following house numbers come packaged with screws.

Solid Brass with Satin Nickel Finish		
ITEM#	DESCRIPTION	MIN QTY
DD07-6S0SN	"0"	10
DD07-6S1SN	"1"	10
DD07-6S2SN	"2"	10
DD07-6S3SN	"3"	10
DD07-6S4SN	"4"	10
DD07-6S5SN	"5"	10
DD07-6S6SN	"6"	10
DD07-6S7SN	"7"	10
DD07-6S8SN	"8"	10
DD07-6S9SN	"9"	10

Solid Brass with Bronze Finish		
ITEM#	DESCRIPTION	MIN QTY
DD07-6S0OB	"0"	10
DD07-6S1OB	"1"	10
DD07-6S2OB	"2"	10
DD07-6S2OB	"3"	10
DD07-6S4OB	"4"	10
DD07-6S5OB	"5"	10
DD07-6S6OB	"6"	10
DD07-6S7OB	"7"	10
DD07-6S8OB	"8"	10
DD07-6S9OB	"9"	10



PLASTIC SURFACE MOUNT

The following house numbers come packaged with nails.

4" Smooth Black		
ITEM#	DESCRIPTION	MIN QTY
HN0	"0"	50
HN1	"1"	50
HN2	"2"	50
HN3	"3"	50
HN4	"4"	50
HN5	"5"	50
HN6	"6" or "9"	50
HN7	"7"	50
HN8	"8"	50

6" Textured Black		
ITEM#	DESCRIPTION	MIN QTY
PB60	"0"	50
PB61	"1"	50
PB62	"2"	50
PB63	"3"	50
PB64	"4"	50
PB65	"5"	50
PB66	"6" or "9"	50
PB67	"7"	50
PB68	"8"	50

EXTERIOR DOOR ACCESSORIES

All items on this page come packaged with installation hardware.

48" LADDER PULL HANDLE

ITEM#	DESCRIPTION	FINISH
EDPI48SS316	Back to Back 1-1/4" Rounded	316 Stainless Steel

ROLLER LATCH

ITEM#	DESCRIPTION	FINISH	MIN QTY
DD05-51SN	Exterior Door Roller Latch	Satin Nickel	25
DD05-512SN	T-Strike for Roller Latch	Satin Nickel	50
DD05-512OB	T-Strike for Roller Latch	Oil Rubbed Bronze	50

PRIVACY LATCH NEW!

ITEM#	FINISH
DD04-36SN	Satin Nickel
DD04-36BL	Matte Black

SURFACE BOLT

ITEM#	SIZE	FINISH
UL45326D	8"	Satin Chrome

DOOR KNOCKER/VIEWERS

9-16" Bore 180 Degree

ITEM#	FINISH
32438	Satin Nickel
32439	Oil Rubbed Bronze

DOOR VIEWERS

180 Degree Solid Brass

ITEM#	DESCRIPTION	FINISH	MIN QTY
DV18015	9-16" Bore	Satin Nickel	12
DV18010B	9-16" Bore	Oil Rubbed Bronze	12
DV915	1/2" Bore	Antique Brass	12
31842	1/2" Bore	Satin Nickel	25
31843	1/2" Bore	Oil Rubbed Bronze	25
31836	1/2" Bore	Bright Chrome	25
DD01-181ULSN	UL Door Viewer for Shaker Door	Satin Nickel	50
DD01-181ULBL	UL Door Viewer for Shaker Door	Black	50



NEW!

GOOSE NECK 2-1/2" x 1-1/2"

ITEM#	FINISH
DD02-73BL	Matte Black
DD02-73SN	Satin Nickel

CRASH CHAIN WITH VINYL COVER

ITEM#	FINISH	MIN QTY
DD08-11	Chrome with Blue Cover	10



WALL MOUNT

With Plastic Drywall Anchor, 2-1/2" Dia

ITEM#	DESCRIPTION	FINISH	MIN QTY
WB250U15	Concave	Satin Nickel	50
WB26US10B	Concave	Oil Rubbed Bronze	50
WB26US32D	Concave	Stainless Steel	50
CONWB42US32D	Convex	Stainless Steel	50



DOOR STOPS

DOOR STOPS

DOOR SAVER III

This ultra-low-profile design creates bumper-less protection for doors and trim. Door-Saver 3 is simple to install on your existing hinge pin. It includes a vinyl bushing to assist in accommodating the various pin diameters as well as to reduce "pin creep."



ITEM#	FINISH	MIN QTY
01234	Satin Nickel	50
01236	Oil Rubbed Bronze	50

DOOR SAVER II

This ultra-low-profile design completely replaces your hinge pin to create bumper-less protection for doors and trim.



ITEM#	FINISH	MIN QTY
01274	Satin Nickel	50
01276	Oil Rubbed Bronze	50
01273	Bright Chrome	50

DOOR SAVER I

This design installs on your existing hinge pin. This allows the door to be stopped without damaging the door or jamb.



ITEM#	FINISH	MIN QTY
01214	Satin Nickel	50
01216	Oil Rubbed Bronze	50
01213	Bright Chrome	50
01215	Antique Nickel	50

HEAVY DUTY HINGE PIN

ITEM#	FINISH	MIN QTY
JHP1115	Satin Nickel	50



SOLID CAST

All items on this page come packaged with installation hardware.

3-1/8" Heavy Duty		
ITEM#	FINISH	MIN QTY
30652	Satin Nickel	100
30654	Oil Rubbed Bronze	100
30647	Bright Chrome	100

NEW!

3" Modern		
ITEM#	FINISH	MIN QTY
DD02-23SN	Satin Nickel	20
DD02-23BL	Matte Black	20

FLEXIBLE SPRING

3-1/8" Heavy Duty		
ITEM#	FINISH	MIN QTY
30619	Satin Nickel	50
30613-10B	Oil Rubbed Bronze	50
30615	Bright Chrome	50

3" Standard		
ITEM#	FINISH	MIN QTY
DD02-30SN	Satin Nickel	100
FS8910B	Oil Rubbed Bronze	100
FS8926	Bright Chrome	100

BARN DOOR HARDWARE

All items on this page come packaged with installation hardware.

KITS & ACCESSORIES MATTE BLACK NEW!

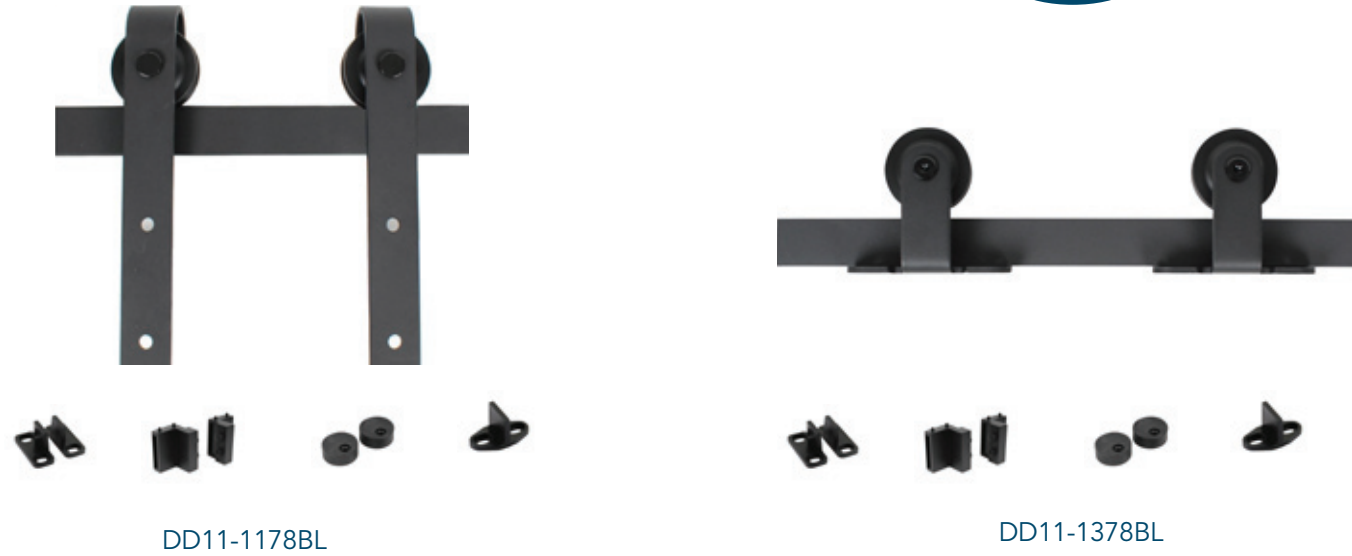

Kits	
ITEM#	DESCRIPTION
DD11-1178BL	Bent Strap
DD11-1378BL	Top Wheel



Accessories	
ITEM#	DESCRIPTION
DD11-10PL2BL	Recessed Flush Pull
DD11-10PL4BL	Flush Door Pull with handle
DD11-12FBGBL	Adjacent Floor Roller Guide
DD11-PL1BL	Door Privacy Latch

Satin Nickel & Stainless Steel available by Special Order.

FLIP LEVER FLUSH BOLTS

All items on this page come packaged with installation hardware.

FOR 1-3/8" WOOD ASTRAGALS



7" Square & Round Corner		
ITEM#	FINISH	MIN QTY
34826	Satin Nickel	10
34825	Oil Rubbed Bronze	10

12" Extension Round Corner		
ITEM#	FINISH	MIN QTY
34830	Satin Nickel	10
34829	Oil Rubbed Bronze	10
EXTFB126	Bright Chrome	10

FOR 1-3/4" WOOD ASTRAGALS



12" Extension Square Corner		
ITEM#	FINISH	MIN QTY
458B10B12	Oil Rubbed Bronze	2
458B2612	Bright Chrome	2
458B26D12	Dull Chrome	2

GENERAL HARDWARE

All items on this page come packaged with installation hardware.

BALL CATCHES

Radius Corner 2-1/4" Strike		
ITEM#	FINISH	MIN QTY
31243	Satin Nickel	100

Drive-in 2-1/4" Strike		
ITEM#	FINISH	MIN QTY
DIB13	Bright Brass	100
DIB115	Satin Nickel	100
DIB110B	Oil Rubbed Bronze	100
DIB15	Antique Brass	100
DIB126D	Satin Chrome	100
DIB126	Bright Chrome	100

Radius Corner 2-1/4" Strike Only		
ITEM#	FINISH	MIN QTY
STRKBC9715	Satin Nickel	10

HANDRAIL BRACKETS

Standard			
ITEM#	DESCRIPTION	FINISH	MIN QTY
33606	Handrail Bracket	Satin Nickel	50
33603	Handrail Bracket	Oil Rubbed Bronze	400

Heavy Duty			
ITEM#	DESCRIPTION	FINISH	MIN QTY
36623	Heavy Duty Bracket	Satin Nickel	50
36626	Heavy Duty Bracket	Oil Rubbed Bronze	50
36633	Heavy Duty Bracket	Oil Rubbed Bronze	50
36634	Heavy Duty Bracket	Satin Nickel	50

CONCEALED SCREW GRAB BARS STAINLESS STEEL

ITEM#	SIZE
BGBSS-1218C	18" x 1-1/4"
BGBSS-1224C	24" x 1-1/2"
BGBSS-1236C	36" x 1-1/2"
BGBSS-1242C	42" x 1-1/2"



GENERAL HARDWARE

All items on this page come packaged with installation hardware.

POCKET LOCKS (1-3/4" x 2-1/4" Cutout)

Our privacy pocket lock is finished with a coined edge unlike most other brands.

ITEM#	DESCRIPTION	FINISH
SDL16US15	Privacy	Satin Nickel
SDL16US10B	Privacy	Oil Rubbed Bronze
SDL16US3	Privacy	Bright Brass
SDL16US5	Privacy	Antique Brass
SDL16US26	Privacy	Bright Chrome
SDL16US26D	Privacy	Satin Chrome
SDL16US19	Privacy	Black
SDL17US15	Passage	Satin Nickel
SDL17US10B	Passage	Oil Rubbed Bronze
SDL17US5	Passage	Antique Brass
SDL17US26	Passage	Bright Chrome
SDL17US26D	Passage	Satin Chrome
SDL17US15A	Passage	Antique Nickel
SDL17US19	Passage	Black

EDGE DOOR PULL 3-7/8" x 3/4"

ITEM#	FINISH	MIN QTY
104619	Satin Nickel	10

DRIVE IN FINGER PULL 2-1/8"

ITEM#	FINISH	MIN QTY
DIFP21815	Satin Nickel	150
DIFP21810B	Oil Rubbed Bronze	150
DIFP21826	Chrome	150

GENERAL HARDWARE

All items on this page come packaged with installation hardware.

SHELF SUPPORT BRACKETS

ITEM#	DESCRIPTION
ADJ42	Adjustable 14" Shelf
FSR123	Heavy Duty 14" Rod & Shelf

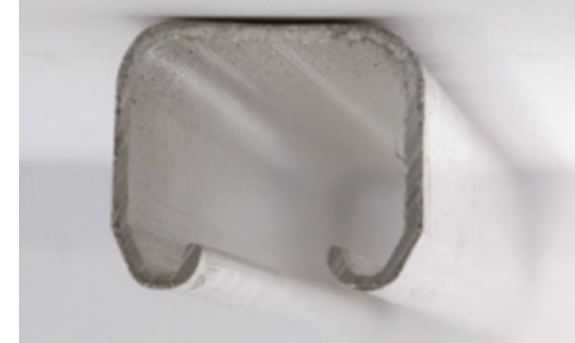

GENERAL HARDWARE

Unless otherwise noted, all items on this page come packaged with installation hardware*

HEAVY DUTY BI-FOLD 4 DOOR TRACK ONLY

Use with 1" to 1 3/4" doors up to 150lbs

* This Track does not come packaged with installation hardware.

ITEM#	SIZE
800804	8/0
8001001	10/0
8001201	12/0
8001601	16/0

POLE SOCKETS 1-3/8" DIAMETER

ITEM#	DESCRIPTION	FINISH	MIN QTY
PSWOOD	Wood Pole Socket	Unfinished	50
PS99	Nylon Pole Socket w/ Screws	White	50



BI-FOLD TRACK ONLY

ITEM#	SIZE
780604	6/0

Specific lengths available by Special Order.



3502111

HEAVY DUTY BI-FOLD 4 WHEEL BALL BEARING HARDWARE SETS

ITEM#	DESCRIPTION
3502111	2 Door
3504111	4 Door

BI-FOLD HARDWARE SET

ITEM#	DESCRIPTION
7802221A2	2 Door Hardware Set w/704 (780)

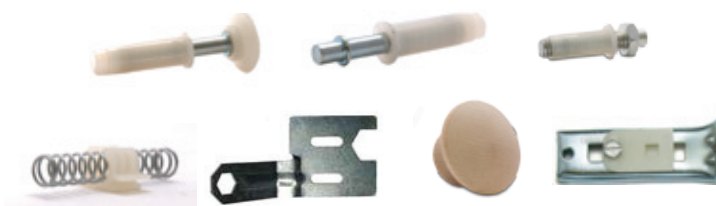

7802221A2



3504111

ADDITIONAL BI-FOLD HARDWARE

ITEM#	DESCRIPTION
404	Hinge - 3 leaf, Polished Brass



404



715

801

802

ADDITIONAL HEAVY DUTY BI-FOLD HARDWARE

ITEM#	DESCRIPTION
801	Top Aluminum Track Bracket
802	4 Wheel Ball Bearing Hanger w/ Door Plate
715	Jamb Floor Bracket w/Round Hole

GENERAL HARDWARE

Unless otherwise noted, all items on this page come packaged with installation hardware*

BI-PASS TRACK

For 1-3/8" Doors With Weight Up To 50 lbs. Each.

Without Fascia	
ITEM#	DESCRIPTION
23540SK	4/0 Track w/Hardware-Shrink Pack
23550SK	5/0 Track w/Hardware-Shrink Pack
23560SK	6/0 Track w/Hardware-Shrink Pack
23540	4/0 Track Only*
23550	5/0 Track Only*
23560	6/0 Track Only*
With Fascia	
ITEM#	DESCRIPTION
24540SK	4/0 Track w/Hardware-Shrink Pack
24550SK	5/0 Track w/Hardware-Shrink Pack
24560SK	6/0 Track w/Hardware-Shrink Pack
24550	5/0 Track Only*
24560	6/0 Track Only*

Specific lengths available by Special Order.

BI-PASS HARDWARE

Note: The hardware bags and bulk parts for the 235 and 245 series are interchangeable. This eliminates any errors in shipping or replacement.

ITEM#	DESCRIPTION
2282122	2 Door Hardware Set (1 piece Guide)
2282112	2 Door Hardware Set (Adjustable Guide)
209	Adjustable Floor Guide - Beige
210	One Piece Floor Guide - White
216	Flush Pull 1-3/4" Plastic - Beige



235



245



2282112



209



210



216



230



2302212



2302113



802

GENERAL HARDWARE

Unless otherwise noted, all items on this page come packaged with installation hardware*

HEAVY DUTY BI-PASS TRACK

USE WITH 1" TO 1 3/8" DOORS

* This Track does not come packaged with installation hardware.

ITEM#	DESCRIPTION
230040	4/0 Track Only
230050	5/0 Track Only
230060	6/0 Track Only
230080	8/0 Track Only
2300120	12/0 Track Only

HEAVY DUTY BI-PASS 2 DOOR HARDWARE SETS

2 each #122 Ball Bearing rollers required for up to 100lbs
 2 each #802 Ball Bearing rollers required for up to 150lbs
 3 each #802 Ball Bearing rollers required for up to 200lbs

ITEM#	DESCRIPTION
2302212	2 Wheel - Plastic Pulls (#122 2 wheel)
2302113	4 Wheel - Nickel Pulls (#802 4 wheel)

ADDITIONAL HEAVY DUTY BI-PASS HARDWARE

ITEM#	DESCRIPTION
802	4 Wheel Ball Bearing Hanger w/ Door Plate

GENERAL HARDWARE

Unless otherwise noted, all items on this page come packaged with installation hardware*

POCKET TRACK ONLY

* This Track does not come packaged with installation hardware.

For 1" To 1-3/4" Doors With Weight Up To 125 lbs. Each	
ITEM#	SIZE
800P40	4/0
800P50	5/0
800P60	6/0



POCKET HARDWARE SETS

2 each #122 Ball Bearing rollers required for up to 100lbs
 2 each #802 Ball Bearing rollers required for up to 150lbs
 3 each #802 Ball Bearing rollers required for up to 200lbs

ITEM#	DESCRIPTION
C120H	2 Wheel
508	4 Wheel



ADDITIONAL POCKET HARDWARE

ITEM#	DESCRIPTION	MIN QTY
802	Hanger - 4 Wheel - Ball Bearing	1
125	One Piece Nylon Guide	1
130	Pocket Door Track Bumper	25



SHIPPING & INSTALLATION PRODUCTS

SHIPPING PROTECTORS

ITEM#	DESCRIPTION	COLOR	MIN QTY
DSFSP	Door Slab Protector - Foam	Black	360
DSCSP	Door Slab Protector - Cardboard	Tan	100
DF4238FJ	Pre-Hung Closure Bolt	Black	1000



ITEM#	DESCRIPTION	Width	Length	Thickness	Packaging
CWPS	Multi-purpose Shims	1-1/2"	8"	5/16 X 1/16"	24 packs of 12 per case

COMPOSITE SHIMS

Waterproof
 Mildew resistant – will not rot
 Impervious to insects
 Resists splitting, splintering, swelling and warping.
 50% greater compression strength than traditional wood shims.

Uses:
 Leveling doors & windows, cabinets & appliances.
 Mixing paints & stains.
 Spreading adhesives and glues.
 Snaps easier than wood at natural break points (perforations).
 Easily drilled and cut.



ITEM#	DESCRIPTION	Width	Length	Thickness	Packaging
SS16	Stackable Shims	1-13/16"	3-1/2"	1/16"	1008 per case

WINDOW SHIMS

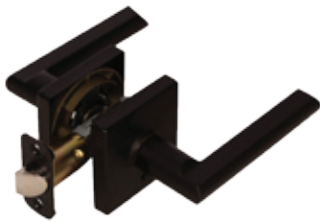

2022 CATALOG

Builders
Hardware
Inc.

© Builders Hardware Inc. 2022