



THE DOOR OF BEAUTY & INNOVATION





We choose a door for its aesthetic qualities, but doors offer so much more than aesthetics. Your front door is a warm familiar place where new guests arrive and a cheerful announcement when friends come. We live our lives through them. Our front door sees us when we start our day and are ready to take on new opportunities. It's also a gentle embrace at the end of the day, welcoming us to our home and family. Doors aren't just doors; they're a reflection of us and our home. They help us and our families feel safe and protected. We know how important it is to choose a door that best represents you, makes you feel secure, and fits your needs.











ABOUT PLASTPRO

Since 1994, Plastpro has always believed in providing a superior product with the best value, technology, and commitment to our customers. Our fiberglass doors offer the beauty and versatility of wood doors, but require less maintenance and have a longer lifespan. Wood and steel doors have been preferred in the industry, but both come with problems such as: rotting, rusting, and weather damage. Our fiberglass doors are the best solution and are not susceptible to weather damage, require less maintenance, and offer higher performance ratings. We've introduced the first door with composite stiles and rails, HydroShield technology, and composite Polyfiber (PF) Frames to the industry. Our doors feature a full length LVL block that provides stronger rigidity and a range of door locks and hardware to be installed for increased security. We carry a wide variety of designs, sizes, and styles that are bound to complement everyone's home.

Since the beginning, we've not only been committed to providing superior products, but also in creating opportunities. Our goal is to create positive changes for not only our employees and customers, but also for our community. We believe in doing good for the world and making a difference. For us, success is only as good as the good it creates. We've continuously partnered with Habitat for Humanity in order to create affordable, green houses for low-income families across the nation. We've donated more than 500 doors to various chapters of Habitat for Humanity and other non-profit organizations. When you buy a Plastpro door, you not only get a beautiful door with the best quality, you become part of Plastpro and join us in giving back to others.

TABLE OF CONTENTS

5 - 7	PLASTPRO'S QUALITY
8 - 11	PF™ DOOR FRAMES
12	CHOOSING YOUR DOOR
13	DOORABILITY
14 - 15	DOOR SERIES OVERVIEW
16 - 27	GLASS OVERVIEW
28 - 29	SPECIALTY SERIES (FIRE RATED, HVHZ, TRIMABLE & RESIDENTIAL ADA)

30 - 35		LIMITED
36 - 43		MODERN
44 - 55		RUSTIC
58 - 65		MAHOGANY
66 - 73		FIR GRAIN
74 - 107		OAK GRAIN
108 - 153		SMOOTH
154 - 169		TRUE WHITE OAK
170 - 177		ONELITE
178 - 181		NOVA

182 - 185	PRE-FINISH KIT & STAIN / PAINT GUIDES
186 - 187	LEED CONTRIBUTIONS
188 - 193	PRODUCT INDEX

PATENTED HYDROSHIELD™ TECHNOLOGY

Our exclusive HydroShield technology protects our doors against moisture and humidity infiltration, by creating a fully composite barrier that encases and protects the door on all six sides. It prevents warping, delamination, corrosion, rotting, and the buildup of mold and mildew. Our doors with HydroShield technology used with our Polyfiber (PF) Door Frames create an enhanced, impenetrable entryway.



1 FIBERGLASS REINFORCED DOOR SKINS

Our exclusive formula is measured precisely to ensure each skin is produced to the highest quality. With unlimited design options, customized panel configurations are possible. The skins require little maintenance and will not splinter, dent, warp, rot, or rust. They can be painted, stained, and we provide a variety of graining options.

2 FULL LENGTH COMPOSITE STILES

Our full-length composite stiles protect the door from external moisture to prevent warping or rotting. They have twice the screw-holding strength of wood.

3 COMPOSITE TOP & BOTTOM RAILS

High strength composite top and bottom rails prevent moisture from seeping into the door and stops the buildup of mold.

4 EXTENDED LOCKBLOCK

Plastpro's full length LVL allows any type of lock to be placed for increased security.

5 POLYURETHANE FOAM CORE

Our advanced CFC-free, high density, Polyurethane foam core enhances the door's soundproofing capabilities and provides insulation up to six times greater than wood doors.



BACKED BY WARRANTY

We are proud to offer one of the best warranties in the industry. Plastpro products are held to high standards. We stand behind our products and guarantee the best quality to meet your performance expectations.

PLASTPRO DOOR



- 1** Full length composite top and bottom rails enhance the durability and performance of the door by preventing any water penetration, which eliminates the natural cracking found with wood.
- 2** High impact skin with beautiful old world craftsmanship will not split, dent, or rust.
- 3** Full length composite stiles offer non-porous protection that prevents water from seeping into the door, which eliminates the natural cracking that occurs with wood.
- 4** Full length LVL block provides stronger rigidity and a range of door locks and hardware to be installed on the door to increase security.
- 5** Polyfiber (PF) Door Frame is durable, long-lasting, and enhances the quality and performance of the entryway when used with our door.

THEIR DOOR



- 1** Composite bottom rails with wood exposed on the bottom of door allowing for moisture penetration.
- 2** Shallow embossed skin resembling steel doors, reducing curb appeal.
- 3** Limited length wood stiles allow moisture to enter creating future maintenance issues.
- 4** Average wood lock block of 12".
- 5** Wood frame material will crack or rot over time.

HydroShield™
technology



ASTM D1761	Screw holding capacity.
NWWDA TM-7	Cycle slam test.
NWWDA TM-8	Hinge load resistance test.
ASTM E 283	Air infiltration.
ASTM E 331 / E 547	Water resistant.
ASTM E 330	Uniform structural load.
ASTM E1886 / E1996	Impact / cycle test.
AAMA 1304	Forced entry resistance test.
TAS 201	Impact test.
TAS 202	Air / water / structural test.
TAS 203	Wind pressure cycle test.
NFRC 100 / 200 / 500	Energy efficiency.
ASTEM E90 / STC / OITC	Sound transmission.
ULC 10 C / NFPA 252 / ASTM E 2074	Fire rated.
CDPH / EHLB METHOD V1.1 2010	Volatile organic chemical emission test.
JIS Z 2801:2001	Antimicrobial products test.
ASTM D1413-07	Antifungal wood plastic composite test.
CSFM 12-7A-1	Exterior wildfire exposure test.
AAMA 1702	Exterior door test for manufactured housing.
AAMA 920	Operating cycle test.
AAMA / WDMA / CSA 101 / I.S./A440 (NAFS)	North america fenestration test.

The PLASTPRO DOOR met requirements for sawing, planing, routing, boring, drilling and chiseling. For more specific results, please see our website at www.plastproinc.com or contact our Customer Service Department at 1 (800) 779-0561.



WARNING: These products may include styrene, titanium dioxide and wood dust, which are known to the State of California to cause cancer. For more information go to www.p65warnings.ca.gov

PFT™ DOOR FRAMES

To have a complete entry system, it is important to consider the material of the door frame. Wood doors and frames are prone to warping, rotting, and cracking, while steel doors and frames can rust and dent. You don't want to install a door that will fail, nor do you want to install a frame that will fail.

Plastpro's Polyfiber (PF) Door Frames are a uniquely formulated and innovative alternative to traditional door frames. They combine the beauty of wood but require less maintenance and have a longer lifespan. The material is durable, long-lasting, and is more thermally resistant than either wood or metal. The advanced system can be installed the same way as traditional wood frames with no added hassle. When used together with a fiberglass door, they create an enhanced, impenetrable entryway.

FEATURES & BENEFITS

- Equipped with HydroShield technology, it will not absorb or wick moisture, and prevents warping, rotting, and splitting.
- Frame is not able to be infested with termites at any point along the structure.
- Has twice the screw holding power of traditional wood door frames.
- More versatility in design. Available in various lengths and widths that can be stained as well as painted.
- Maintenance free and energy efficient.
- Continuous piece with no finger joint and is 25% more rigid than wood frames.

FRAME DECAY COMPARISON



PLASTPRO PFT™ DOOR FRAME

*with Hydroshield Technology™



TRADITIONAL WOOD FRAME

Susceptible to rotting, warping and decay



4 5/16" DOOR FRAME



6 5/16" DOOR FRAME



5 1/4" DOOR FRAME



7 1/4" DOOR FRAME



1 1/4" x 3" FRAME EXTENSION



WM180 BRICK MOULD

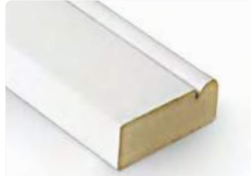

WM176 FL. BRICK MOULD



1" x 2" STUCCO MOULD



PRIMED BACKBAND



NAILING FIN

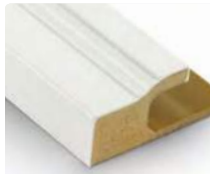

J-CHANNEL



FLAT CASING



FLAT CASING J-CHANNEL



TRIM BOARDS

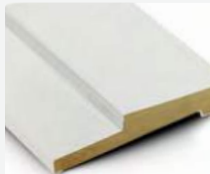

TRANSOM SILLS

- 4 5/16"
- 6 5/16"



MULL POSTS

- 1 1/2" x 3 9/16" x 2 1/2"
- 1 1/2" x 4 3/8" x 2 1/2"
- 1 1/2" x 3 9/16" x 2"
- 1 1/2" x 4 3/8" x 2"



MULL POST COVERS (EXT.)

- 1 1/2" x 1"
- 2" x 1"



MULL POST CAP

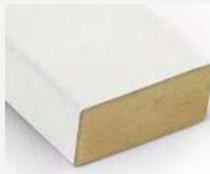

STORM DOOR ADAPTERS

- 1" x 2 1/2"
- 1" x 3"



SIDELITE STOPPER



ASTRAGAL



PFT™ ARCH HEADERS



PFT™ RADIUS HEADERS

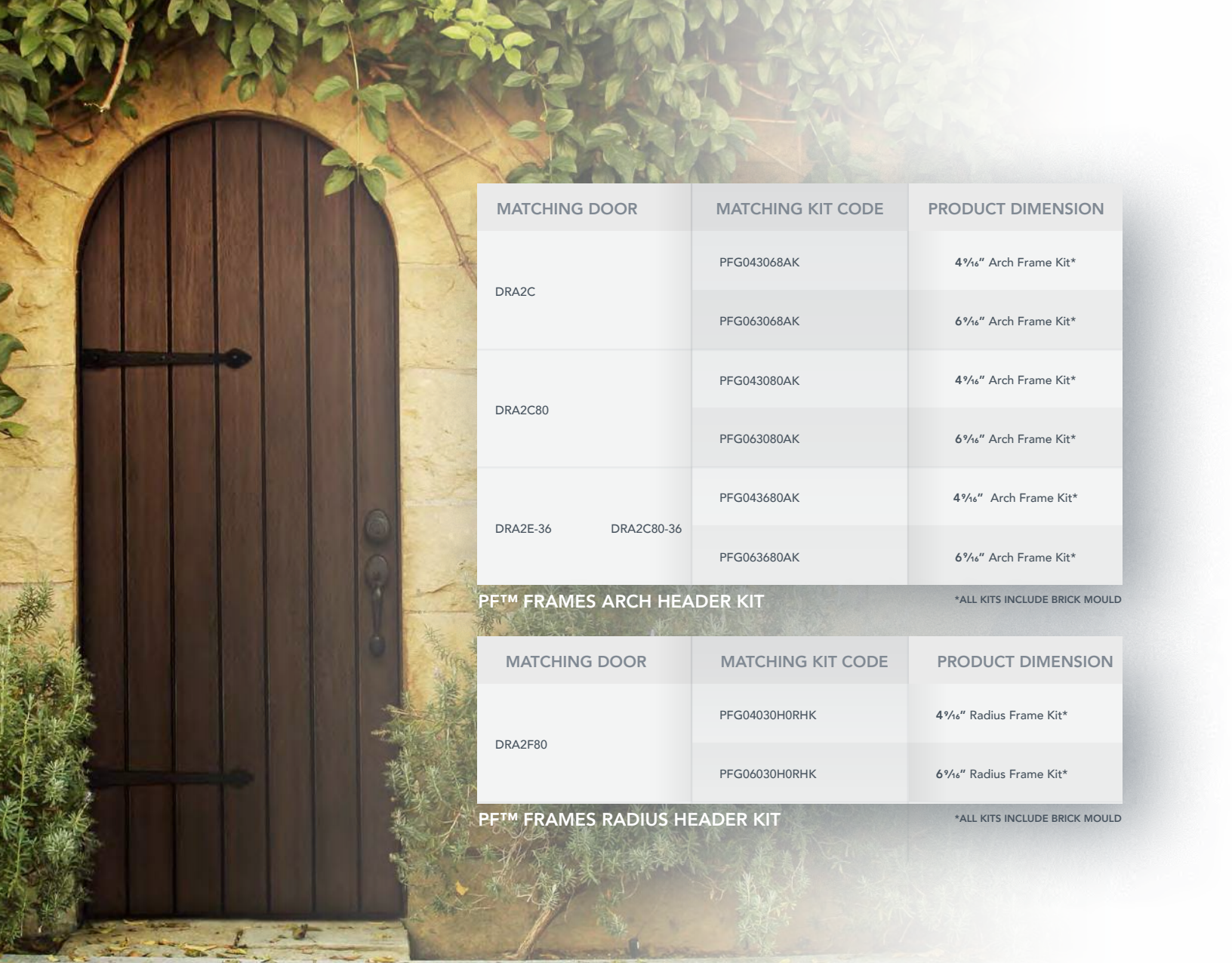

MATCHING DOOR	MATCHING KIT CODE	PRODUCT DIMENSION
DRA2C	PFG043068AK	4 ⁹ / ₁₆ " Arch Frame Kit*
	PFG063068AK	6 ⁹ / ₁₆ " Arch Frame Kit*
DRA2C80	PFG043080AK	4 ⁹ / ₁₆ " Arch Frame Kit*
	PFG063080AK	6 ⁹ / ₁₆ " Arch Frame Kit*
DRA2E-36 DRA2C80-36	PFG043680AK	4 ⁹ / ₁₆ " Arch Frame Kit*
	PFG063680AK	6 ⁹ / ₁₆ " Arch Frame Kit*

PFT™ FRAMES ARCH HEADER KIT

*ALL KITS INCLUDE BRICK MOULD

MATCHING DOOR	MATCHING KIT CODE	PRODUCT DIMENSION
DRA2F80	PFG04030H0RHK	4 ⁹ / ₁₆ " Radius Frame Kit*
	PFG06030H0RHK	6 ⁹ / ₁₆ " Radius Frame Kit*

PFT™ FRAMES RADIUS HEADER KIT

*ALL KITS INCLUDE BRICK MOULD

ARCH & RADIUS HEADER KITS

The shape of an arched and radius door isn't the only thing that makes it different from a traditional rectangular door. Arch doors exude style and give your entryway a brand new look. Plastpro is the only fiberglass door manufacturer able to offer full composite frames to match arch or radius top doors.

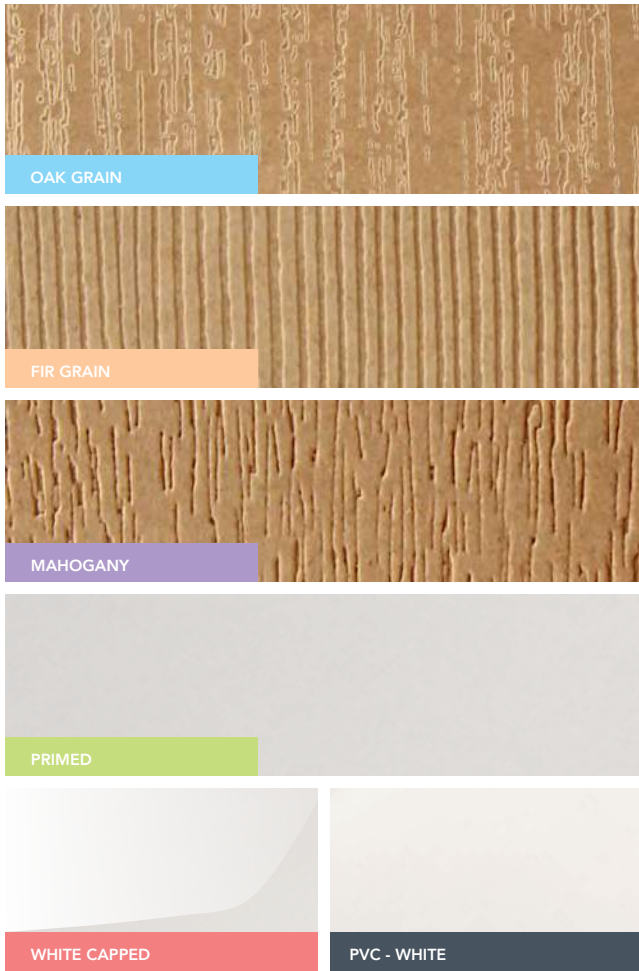

Plastpro Polyfiber (PF) Door Frames are produced with the highest quality and are available in a variety of graining options. For a detailed list of graining available per product, please refer to the chart below.

	OAK GRAIN	FIR GRAIN	MAHOGANY	PRIMED	WHITE CAPPED	PVC - WHITE
4 9/16" DOOR FRAME	●	●	●	●	●	
5 1/4" DOOR FRAME	●			●	●	
6 9/16" DOOR FRAME	●	●	●	●	●	
7 1/4" DOOR FRAME	●			●	●	
WM180 BRICK MOULD	●	●	●	●	●	
WM176 FLORIDA BRICK MOULD	●			●		
1" x 2" STUCCO MOULD				●		
PRIMED BACKBAND				●		
NAILING FIN	●			●	●	
J-CHANNEL	●			●	●	
FLAT CASING	●			●	●	
FLAT CASING J-CHANNEL	●			●	●	
TRIM BOARDS						●
TRANSOM SILLS	●	●	●	●	●	
MULL POSTS	●	●	●	●	●	
MULL POST COVERS (EXTERIOR)	●	●	●	●	●	
MULL POST CAP	●					●
STORM DOOR ADAPTERS	●	●	●	●	●	
DOOR FRAME EXTENSIONS	●	●	●	●	●	
SIDELITE STOPPER	●			●		
ASTRAGAL						●
PFT™ ARCH & RADIUS HEADERS	●					

CHOOSING YOUR DOOR SYSTEM

STEP 1: CHOOSE DOOR TYPE & PANELING

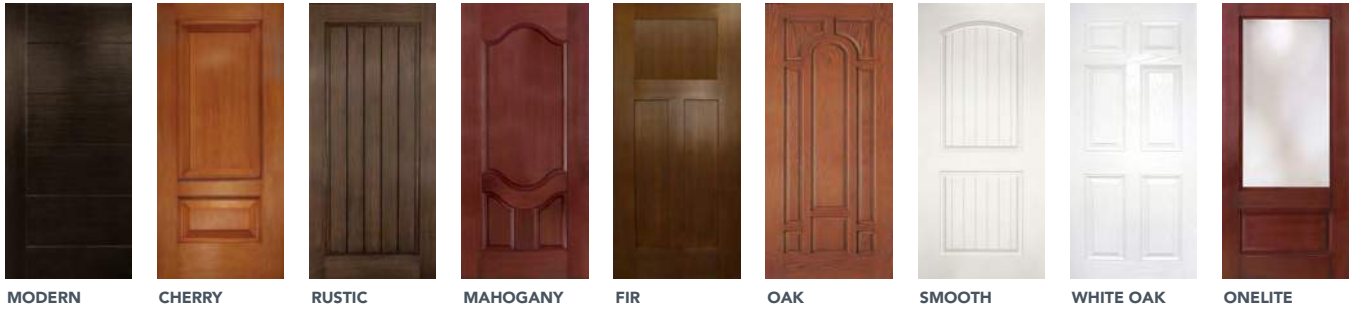

STEP 2: CHOOSE DECORATIVE GLASS



STEP 3: CUSTOMIZE YOUR ENTRY SYSTEM

- CREATE A DOUBLE DOOR ENTRY WAY
- ADD ONE OR TWO MATCHING SIDELITES
- ADD A MATCHING TRANSOM
- ADD DOOR ACCESSORIES
- COMPLETE WITH PF™ DOOR FRAME



STEP 4: CHOOSE FINISH

Plastpro's Pre-Finish Staining Kit contains everything you need to stain one prehung door and two sidelites, or one double door unit.

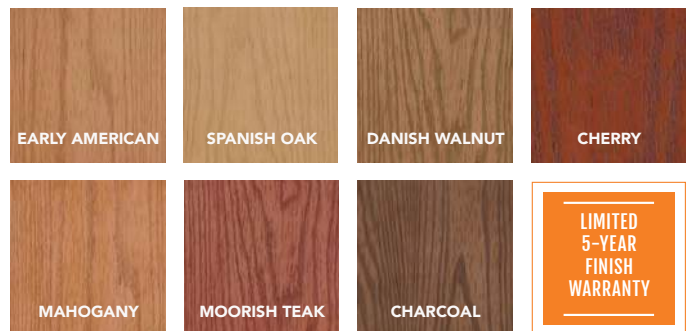

CHOOSE YOUR DOOR DIGITALLY

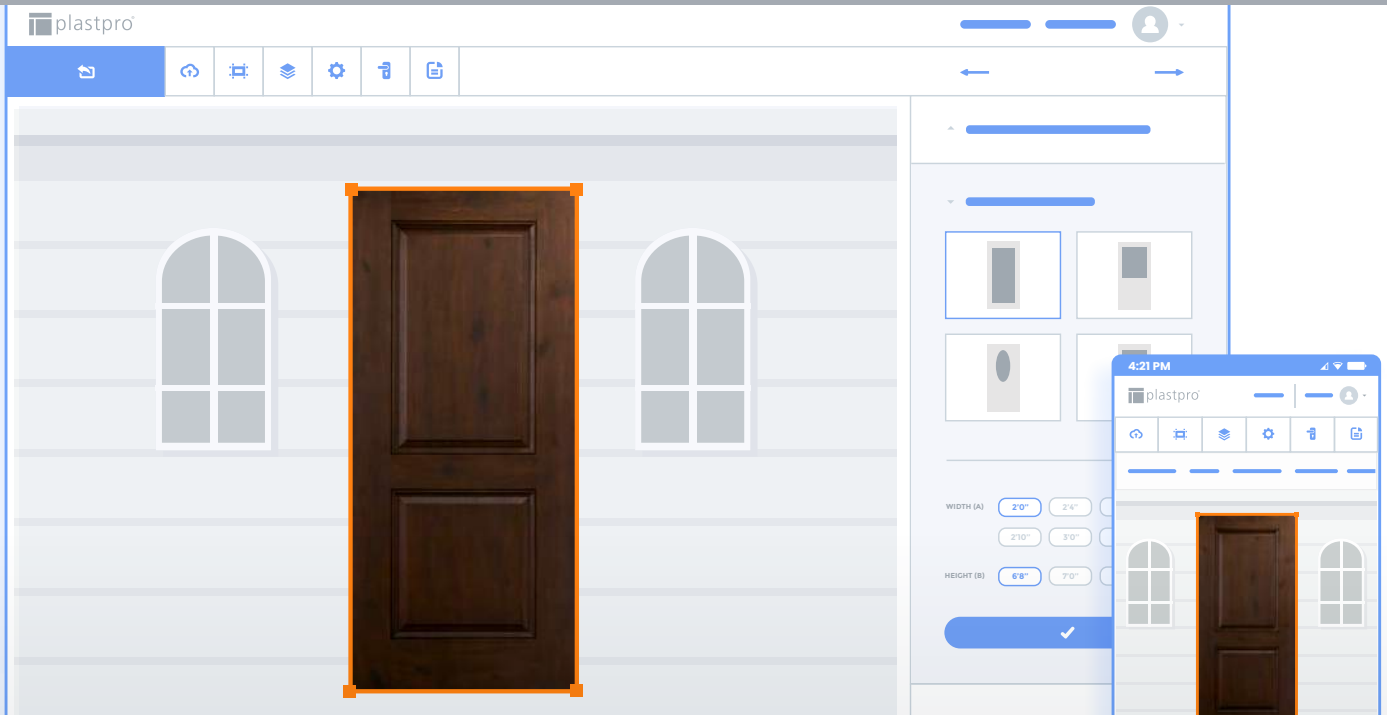

Sometimes it's hard to imagine what a door would look like on your home. A unique home like yours needs a door to complement it perfectly. Our Doorability tool takes the guess work out and lets you see our doors on your home. We have designed a visualizing tool that allows you to upload a photo of your home and instantly add a variety of door and glass options to visual your homes new door.

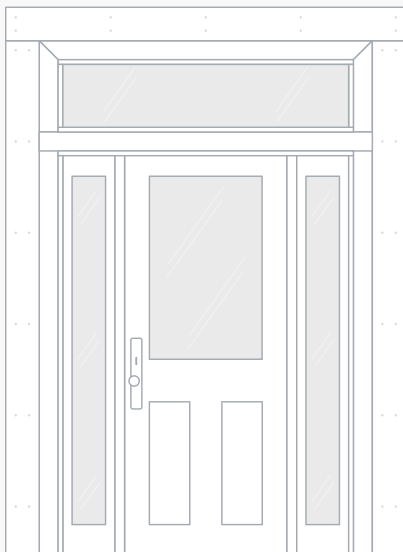

CUSTOMIZE YOUR DREAM ENTRY WAY AT doorability.plastproinc.com

- EASY TO USE
- VISUALIZE THE PERFECT DOOR ON YOUR HOME
- SAVE AND EMAIL YOUR CUSTOM DOOR
- DRAW IN YOUR OPENING FOR AN ACCURATE VISUALIZATION

LIMITED



Our Limited Series was specifically selected to showcase some of the richest, luxury graining available.

MODERN



The Modern Series effortlessly makes a contemporary design simpler.

RUSTIC



Our Rustic Doors were designed to provide classic charm, while bringing traditional, upscale appeal to any home.

MAHOGANY



The Mahogany Series brings a beloved wood texture into traditional, timeless styles.

FIR GRAIN



Our Fir Grain Series creates fine details and gives your home a traditional, craftsman appeal.

OAK GRAIN



Dressed in a rich oak grain texture, our Oak Grain Series gives a classic look to your home.

SMOOTH



The Smooth Series is made with a pre-pigmented white skin. Its simplicity gives a clean, minimal look to any of our fiberglass doors.

TRUE WHITE OAK



The True White Oak Series combines the best features from our Smooth and Oak Grain doors. Any home can enjoy a rich oak texture pattern in a pre-pigmented white skin.

ONELITE



Our Onelite Series features a fine, flush glazed glass with a removable stop to allow the glass to be switched without changing the entire door.

NOVA



The Nova Series was inspired by the gentle, rising light that causes a calm, peaceful feeling experienced in the early morning.



GLASS OVERVIEW

PAGES 16 - 27

A beautifully designed entryway helps set the stage for the rest of the home and creates a welcoming passage from public space to private abode. Nothing accomplishes that better than our exclusive glass designs that improve the look and value of your home while adding beauty to your everyday living.

Our doorlites are composed of a piece of decorative glass sealed between two pieces of tempered safety glasses, that provide excellent safety, sound, and thermal performance.

The state-of-the-art Warm Edge spacer system provides a seal that protects and insulates your door & home for years to come. Unlike the competition, our metal caming includes a gasket that cushions & protects the glass from chipping, cracking, and rattling during door movement.

DOORLITE

INSULATING SYSTEM

All Plastpro Decorative Doorlites are made with Super Spacer® Cushion Edge™, a flexible, U-shaped, silicone foam tape product used to wrap around and cushion our center decorative panel. Featuring a vapor barrier backing, the product used in combination with Hot Melt butyl, provides a superior Warm-Edge seal.

PERFORMANCE FEATURES

Warm-Edge Benefits: Superior silicone foam insulation, low thermal conductivity

Silicon Foam Features: Excellent UV resistance and extreme temperature performance

Dual-Seal Performance: Chamfered corners for increased sealant depth

Tempered Safety Glass for your peace of mind

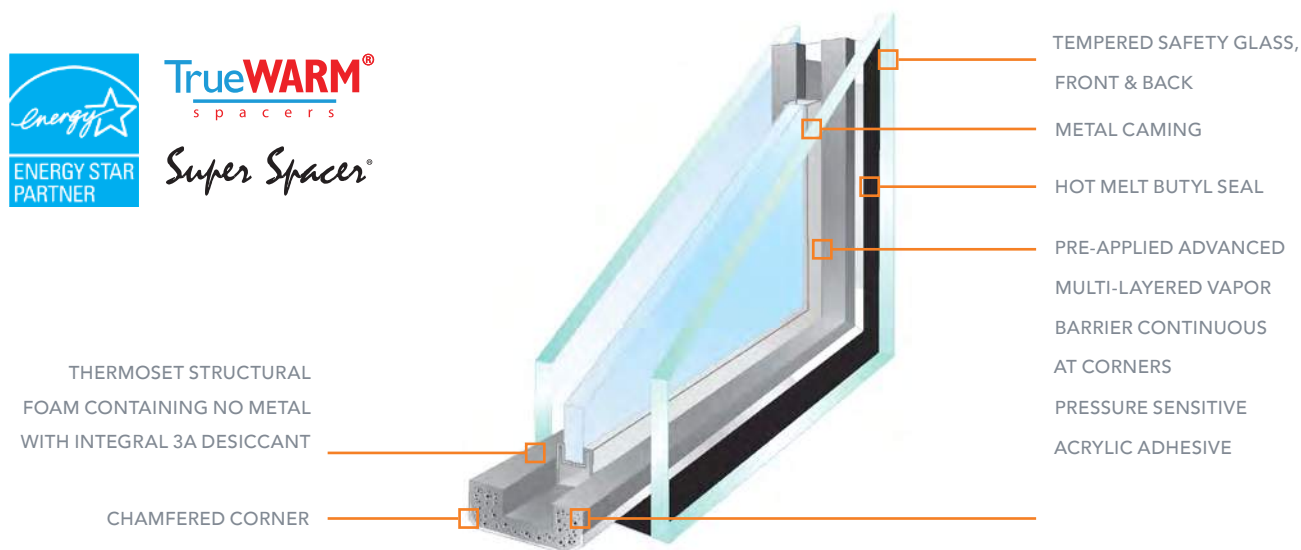

*This illustration applies to our triple pane glass only.

GLASS CAMING

GLASS CAMING OPTIONS

Our exclusive glass designs are offered with different caming options to match a variety of hardware finishes.



WROUGHT IRON



PATINA



ZINC

GLASS FRAMES

BTHP™ SNAP-ON FRAMES

Our exclusive BTHP™ Snap-on Frames employ a series of specially designed clips that lock decorative glass firmly in place. Our BTHP™ Frames have no unsightly plugs or screws, and create a cleaner, more natural appearance in any entryway. Able to withstand temperatures over 200 degrees Fahrenheit, this frame is perfect for use in any door.



WROUGHT IRON FRAMES

This maintenance-free Wrought Iron doorlite frame resists rust and corrosion while working to keep cold out in the winter and heat out in the summer. Specially engineered to complement the range of cutouts in the Rustic Series, each frame is beautifully hand made and has a durable powder coat finish. May also be used in select Smooth Skin, Woodgrain, and True White Oak doors.



CAMELIA

CAMING: WROUGHT IRON
TRANSOM: AVAILABLE



Camelia's wrought iron curves create symmetry, uniformity, and a sense of balance to a door's appearance. Against a waterfall textured background, the design gives the exterior of your home a modern and sophisticated charm, while delivering the ultimate level of privacy.

- 1 Wrought Iron
- 2 Waterfall Tempered Glass



PRISCILLA

CAMING: WROUGHT IRON
TRANSOM: AVAILABLE



Priscilla's smooth swirl design pays tribute to Renaissance style. The wrought iron and little bubble glass gives the design a touch of grandeur, which is perfect for any home looking for an elegant flair.

- 1 Wrought Iron
- 2 Little Bubble Tempered Glass

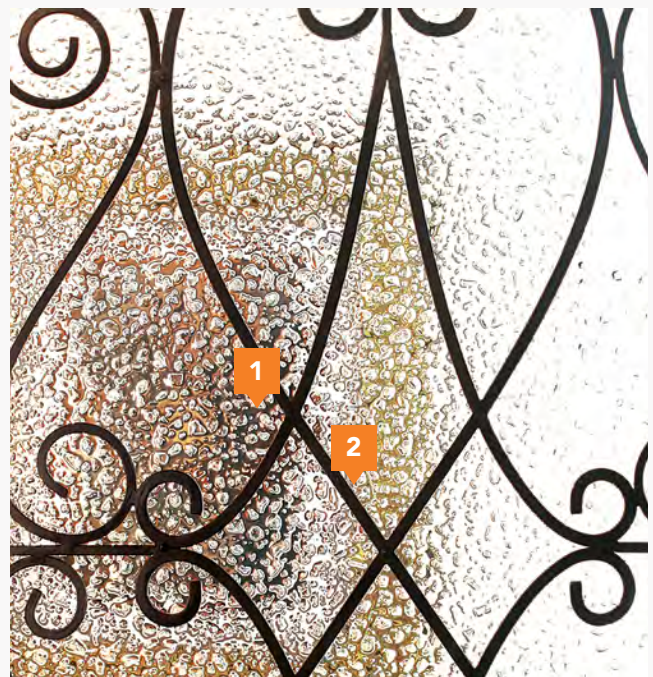

CHIANTI

CAMING: WROUGHT IRON
TRANSOM: AVAILABLE



Sometimes less is more. Chianti's simple, geometric pattern is minimal, but creates a strong yet subtle arrangement. Paired with rain glass, this design will complement any home.

- 1 Wrought Iron
- 2 Rain Glass



ABERDEEN

CAMING: ZINC
TRANSOM: AVAILABLE



There is more than meets the eye. Although simple in design, Aberdeen gives a modern, clean profile, and its translucent reed glass is perfect for maintaining a high level of privacy to your home.

- 1 Zinc Caming
- 2 Reed Glass



ARTESANO

CAMING: PATINA
TRANSOM: AVAILABLE



Artesano's subtle hint of amber colored glass creates a warm welcoming feeling to any home. This arrangement is the ideal balance between a clear, simple pattern with a combination of glass textures.

- 1 Clear Hammer (100HS)
- 2 Patina Caming
- 3 Amber Glass
- 4 Sea Spray
- 5 Clear Bevel



PRIVACY RATING
INCREASING OBSCURITY →

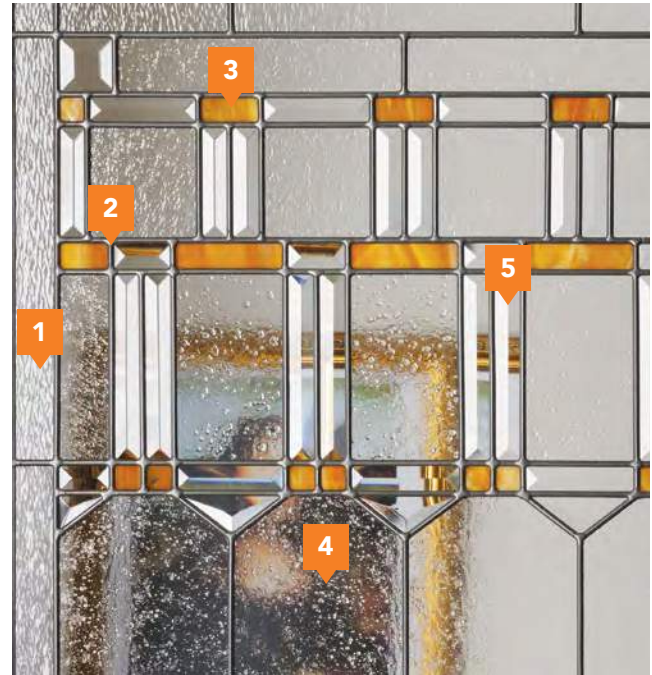

ARTESANO BREEZE

CAMING: ZINC
TRANSOM: AVAILABLE



Artesano's classic design is a tasteful blend of small and large geometric shapes. This pattern's transparent features work to create a sophisticated, decorative, and elegant look to any entry door.

- 1 Clear Hammer (100HS)
- 2 Zinc Caming
- 3 Clear Bevel
- 4 Sea Spray



PRIVACY RATING
INCREASING OBSCURITY →

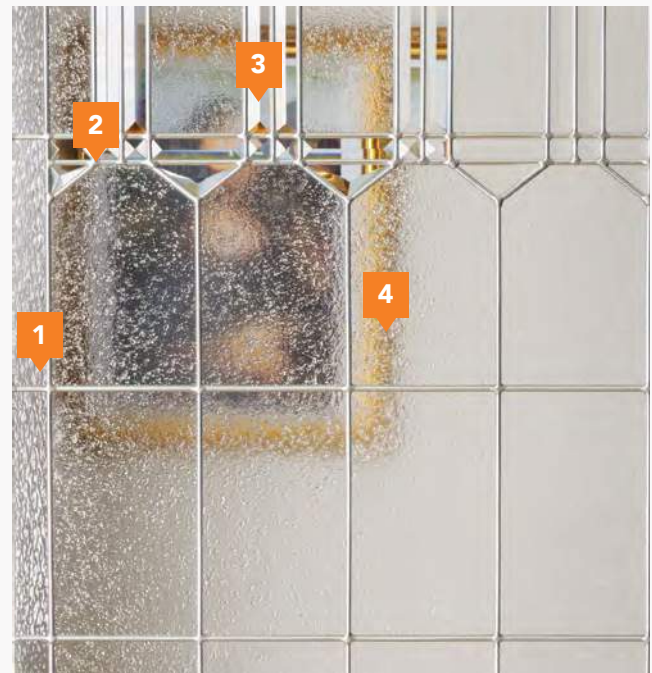

BRENTWOOD

CAMING: ZINC OR PATINA
TRANSOM: AVAILABLE



A classic inspired arrangement, our Brentwood piece epitomizes style. With bevel swirls and a bold centerpiece all outlined by a crystal granite border, Brentwood can be appreciated in any home.

- 1 Baroque
- 2 Clear Bevel
- 3 Bright Zinc, or Patina Caming
- 4 Granite



CASTILE

CAMING: PATINA
TRANSOM: AVAILABLE



Inspired by the historical Spanish kingdom, Castile is as ornate as its nature and history. The baroque style glass balances the intricacy of its centerpiece with a straight-lined, beveled border. Castile is the epitome of modern design.

- 1 Granite
- 2 Baroque
- 3 Patina Caming
- 4 Beveled

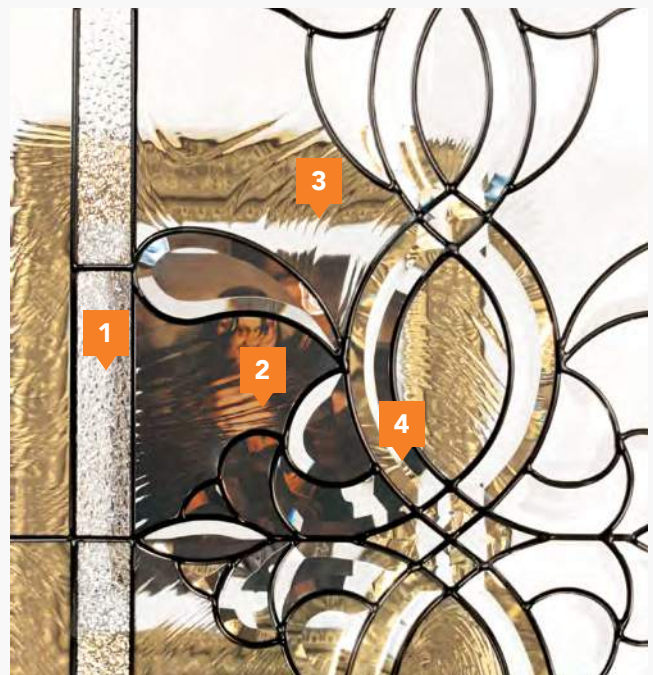

CHARLOTTE

CAMING: ZINC OR PATINA
TRANSOM: AVAILABLE



The combination of patterns and an ornately constructed centerpiece magnify the grand nature of our Charlotte glass. With French influence, this bright, inviting design is perfect for any entrance door.

- 1 100 Water
- 2 Lava
- 3 Clear Bevel
- 4 Bright Zinc, or Patina Caming

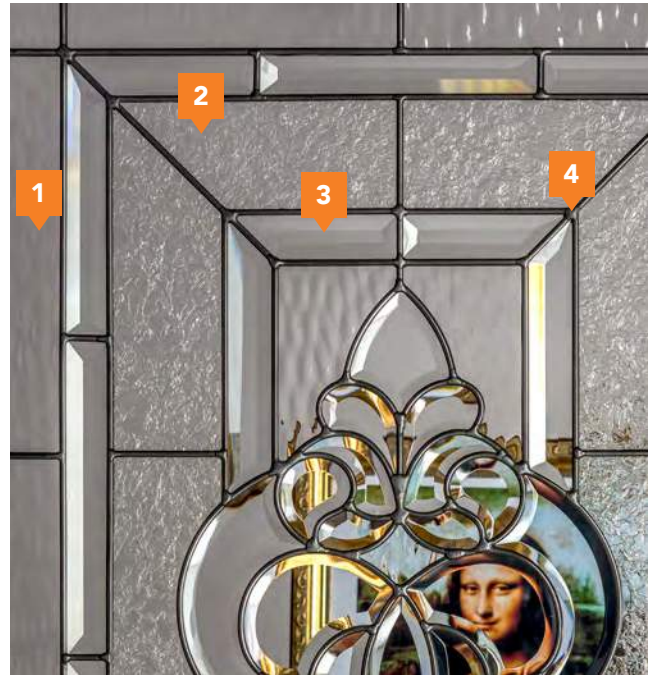

ELIZABETH

CAMING: PATINA
TRANSOM: AVAILABLE



Elizabeth's elegant combination of textured glass and geometric patterns is reminiscent of traditional craftsman style. The patina caming complements all aspects of your door right down to the hardware.

- 1 Granite
- 2 Sable
- 3 Mistlite
- 4 Patina Caming



KENSINGTON

CAMING: PATINA
TRANSOM: AVAILABLE



Kensington brings a classic English atmosphere to anyone's curb appeal. A combination of frosted glass and subtle line patterns gives a high level of charm to this distinct beauty.

- 1 100 Water
- 2 Clear Bevel
- 3 Narrow Reed
- 4 Sandblasted Glass
- 5 Patina Caming



PRIVACY RATING
INCREASING OBSCURITY →

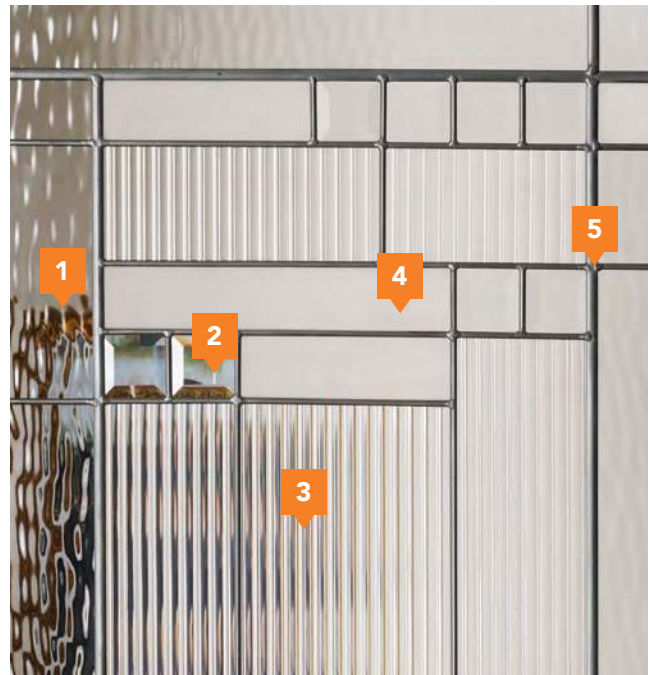

OXFORD

Although simple, Oxford's frosted glass with clear glass outlines adds an elegant touch. The luminous glass adds a high level of privacy. With a hint of modern dimension, any home can benefit from its polished appearance.

- 1 Clear
- 2 Satin Etch



PRIVACY RATING
INCREASING OBSCURITY →

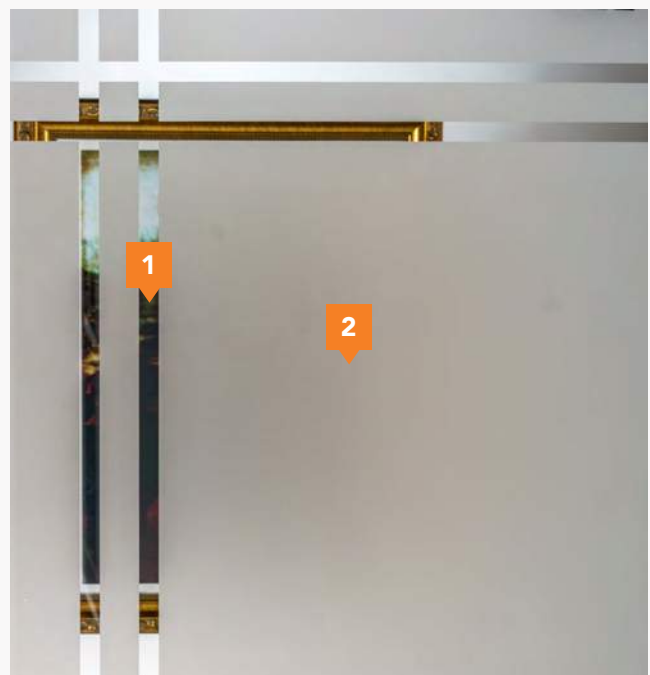

SOLSTICE

CAMING: PATINA
TRANSOM: AVAILABLE



Our Solstice creates a beautiful, simplistic arrangement of frosted glass bordered by patina coming outlines. This stylistic design is bound to leave a lasting impression to any home.

- 1 Sable 3.0 MM Outer Border
- 2 Clear Pencil Bevel for Inner Border
- 3 Sable Bevels Center Background
- 4 Patina Caming



PRIVACY RATING
INCREASING OBSCURITY →



SPRING

CAMING: PATINA
TRANSOM: AVAILABLE



This chevron pattern arrangement emphasizes clean-cut arrows with two toned glass colors. It provides a subtle charm to its otherwise simple pattern. The pale gray, water-like glass texture gives a sense of energy and renewal reminiscent of spring.

- 1 Light Water
- 2 Clear Chord
- 3 Pale Gray Water
- 4 Patina Caming



PRIVACY RATING
INCREASING OBSCURITY →

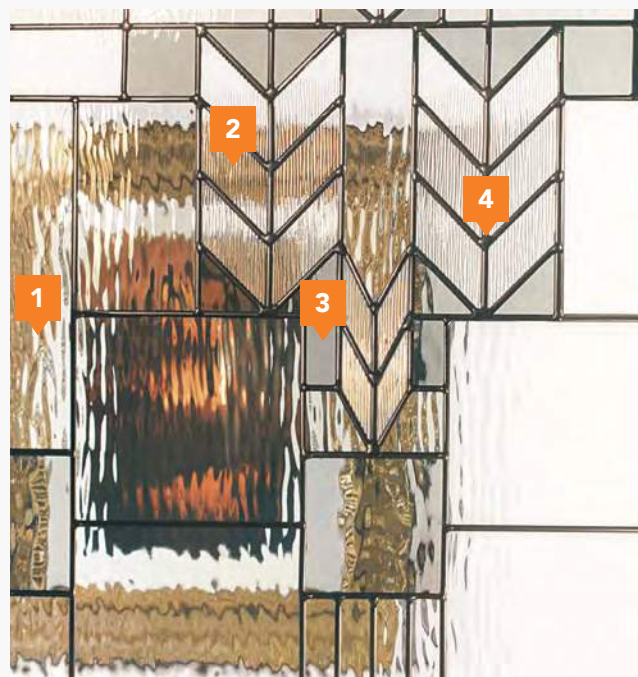

TABITHA

CAMING: PATINA
TRANSOM: AVAILABLE



A clustered flower atop Tabitha is the perfect accent to this romantic centerpiece. The mix of patterns and textures give the arrangement a fluid, contemporary design that will always be admired.

- 1 Granite
- 2 Double Water
- 3 Clear Bevel
- 4 Patina Caming



PRIVACY RATING
INCREASING OBSCURITY →



MINIBLINDS

CAMING: Clear Insulated Glass & LoE Glass

Our Miniblinds offer a clean, cordless design that utilizes a single, easy-to-use lever to control the height and tilt of your blinds. Encased between either our LoE or Clear IG sealed glass, there are no exposed cords, blinds require no dusting, and the sealed glass unit increases energy efficiency.

- 1 Miniblind
- 2 Clear IG or Low-E Glass



PRIVACY RATING
INCREASING OBSCURITY →

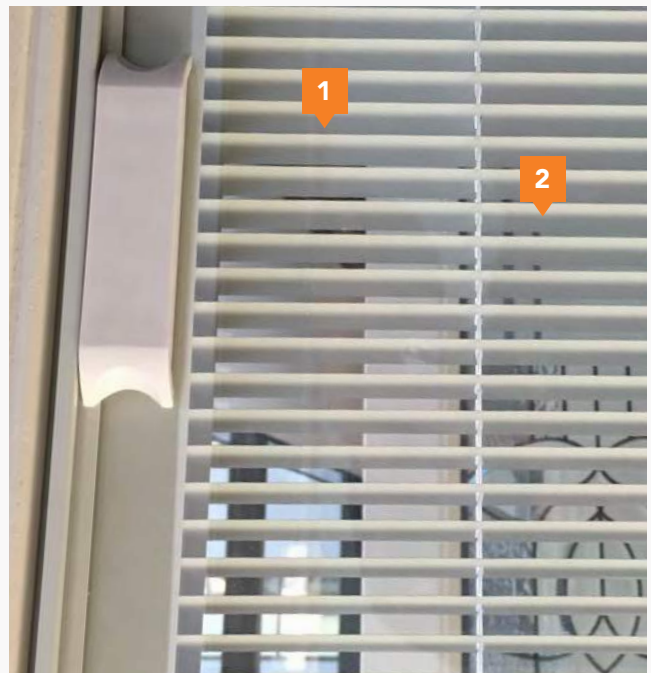



Knotty Alder Door • DRK2B

FIRE RATED



Made with fire-resistant composite, Plastpro Fire Rated doors are extremely durable. Our doors are tested and comply with safety and performance standards to withstand fire for a minimum of 20 minutes. Certain models are available to hold off fire for 60 and 90 minutes. Most importantly, our doors provide a safe home without ever sacrificing style.



= 20min rating option available



= 60min rating option available



= 90min rating option available

Contact us for stock availability.



TRIMMABLE

Our Trimmable Series is designed to fit in a variety of existing entry ways. Adjustments up to 2" in height and width can be made to the door through your contractor. Trimmable doors are available in Oak and Smooth skin. This is the door your home has been waiting for.



= Trimmable Option Available. Contact us for stock availability. (Only available in 3'0" width)



HVHZ IMPACT



Plastpro's High Velocity Hurricane Zone (HVHZ) Impact Doors are engineered to withstand the force of flying objects, while maintaining all the benefits and beauty of our door aesthetic. Our Impact Doors are created, tested, and certified to meet the most stringent wind and impact code requirements in the nation. Our innovative R&D Department has pioneered a unique patent-pending process whereby a missile-proof shield is built-in to reinforce the door.

 = HVHZ Option Available. Contact us for stock availability.

RESIDENTIAL ADA

Our Residential ADA doors are offered in a variety of styles that fulfill all compliances. From Modern to True White Oak, our Residential ADA series has a 10" bottom rail that allows a kick plate to be installed. We have the option to include reinforced blocking through a special order.

 = Residential ADA Option Available. Contact us for stock availability.



LIMITED SERIES



Knotty Alder Door • DRK2B



Cherry Door • DRC21

Our Limited Series was specifically selected to showcase some of the richest, luxury graining available. The Cherry, Knotty Alder, and Teak doors are fine, subtle, but detailed. Cherry is a premium American hardwood, prized for its natural luster and attractive grain. Knotty Alder is admired for its subtle swirls and rich grain pattern with sound knots. Teak is a worldwide favorite for its beautiful straight, yet occasionally wavy or interlocked grain patterns. These grains exude an authentic wood grain and are so versatile they will complement any home.

ALL LIMITED DOORS ARE SHOWN PRE-FINISHED

6'8"



3'0"

DRC21



6'8"



2'8" • 2'10" • 3'0" • 3'6"

DMT51

7'0"



3'0" • 3'6"

DMT5170

6'8"



2'8" • 2'10" • 3'0"

DRK2B



CHERRY TWO PANEL DOOR

6'8"



DRC21

SLC21

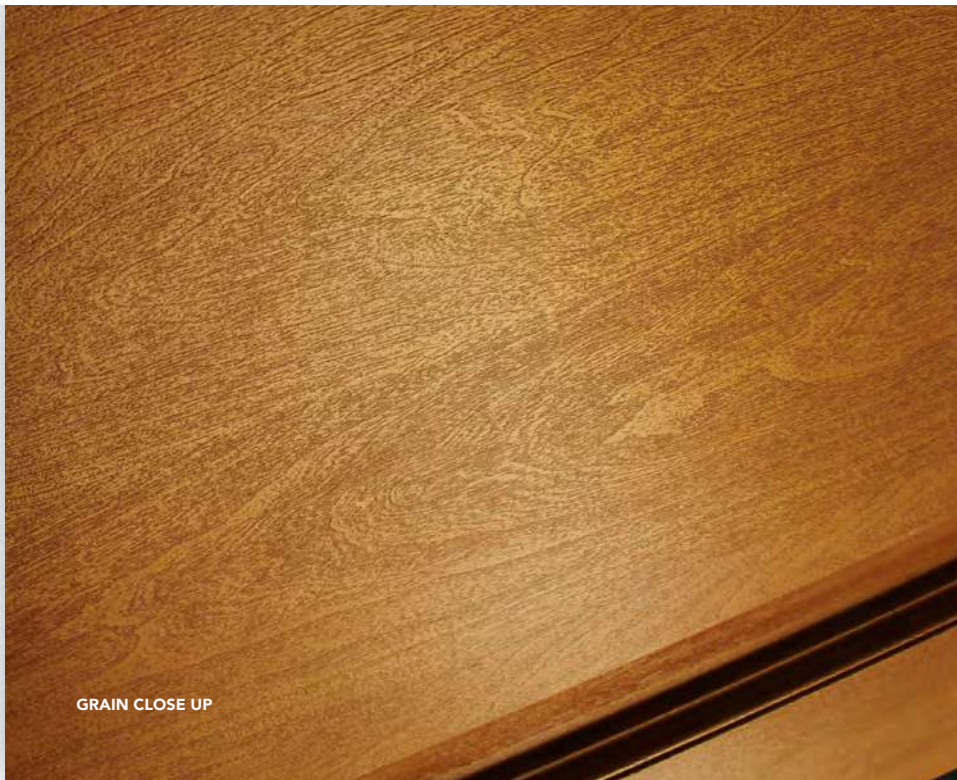

GRAIN CLOSE UP

GLASS OPTIONS

6'8"



CAMFL7

6'8"



PACLFL7

6'8"



CHIFL7

6'8"



ABRFL7Z

6'8"



ARTFL7P

6'8"



ARZFL7Z

6'8"



BREFL7P/Z

6'8"



CASFL7P

6'8"



CHRFL7P

6'8"



ELZFL7P

6'8"



KENFL7P

6'8"



OXFFL7

6'8"



SOLFL7P

6'8"



SPRFL7P

TWO PANEL DOOR

6'8"



TABFL7P

6'8"



MBC/MBLFL7

6'8"



CAMFL1

6'8"



PCLFL1

6'8"

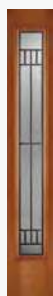

CHIFL1

6'8"



ABRFL1Z

6'8"



ARTFL1P

6'8"



ARZFL1Z

6'8"



BREFL1P/Z

6'8"



CASFL1P

6'8"



CHRFL1P

6'8"



ELZFL1P

6'8"



KENFL1P

6'8"



OXFFL1

6'8"

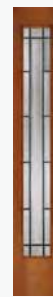

SOLFL1P

6'8"



SPRFL1P

6'8"



TABFL1P

6'8"



MBC/MBLFL1

MODERN TEAK MILAN DOOR

6'8"

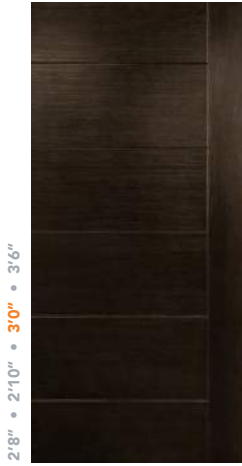

2'8" • 2'10" • 3'0" • 3'6"

DMT51

7'0"



3'0" • 3'6"

DMT5170



GRAIN CLOSE UP

SQUARE TOP

KNOTTY ALDER TWO PANEL DOOR

6'8"

28" • 2'10" • 30"



DRK2B



GRAIN CLOSE UP

● IN STOCK ● EXTENDED LEAD TIME

LIMITED SERIES



35

MODERN



Oak Modern Door • DMG46



The Modern Series effortlessly makes a contemporary design simpler. Our doors are designed to have a cleaner style by incorporating clean, simple lines and single patterned glass. This clean look can complement any homes interior and exterior.

ALL MODERN DOORS ARE SHOWN PRE-FINISHED

DOOR OVERVIEW



MODERN OAK SOUTH BEACH DOOR

6'8"

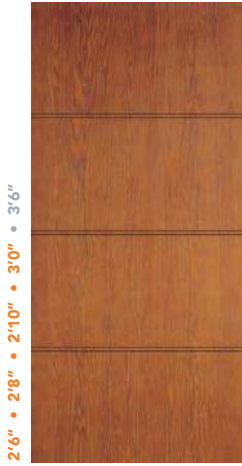

DMG46

8'0"

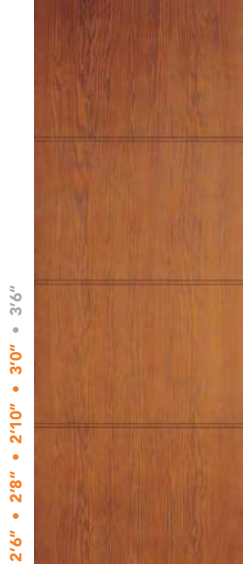

DMG4680

MODERN OAK NAPOLI DOOR

6'8"



DMG51

8'0"



DMG5180

MODERN SMOOTH BIENVENUE DOOR

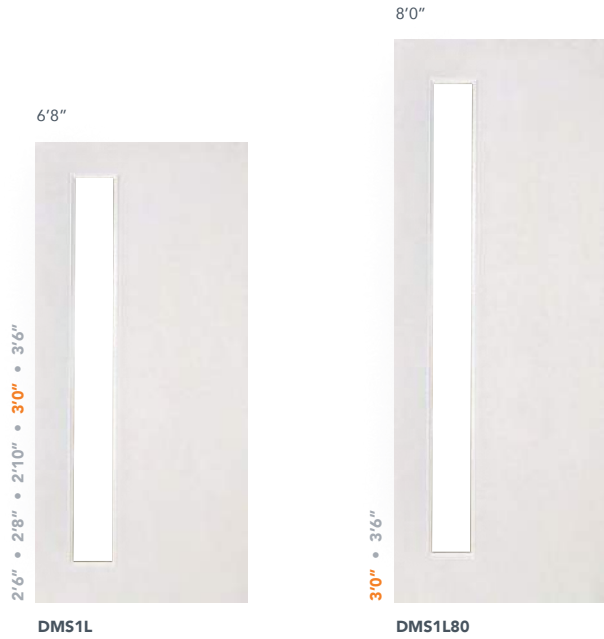

GLASS OPTIONS



MODERN GLASS CLOSE UP

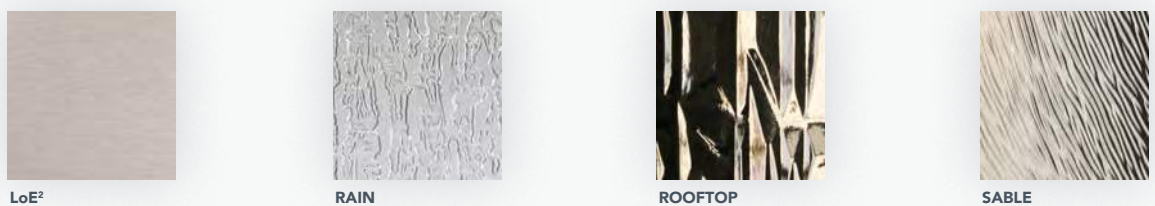

MODERN SMOOTH BIENVENUE DOOR

FLUSH GLAZED SINGLE RIGHT LITE

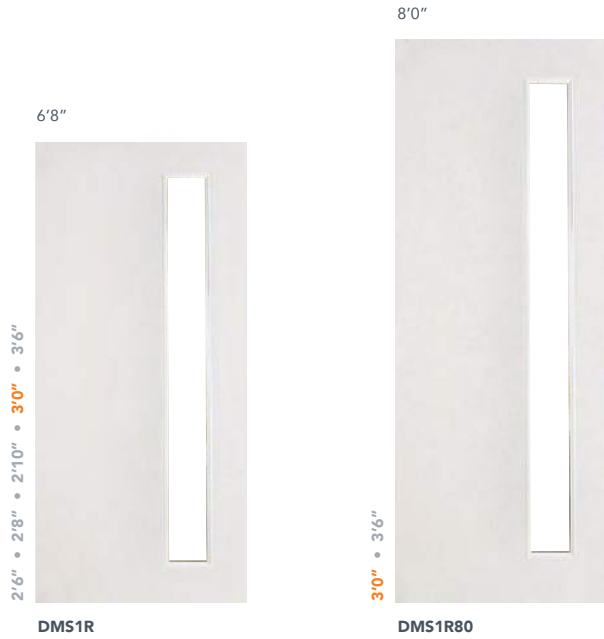

GLASS OPTIONS



MODERN GLASS CLOSE UP

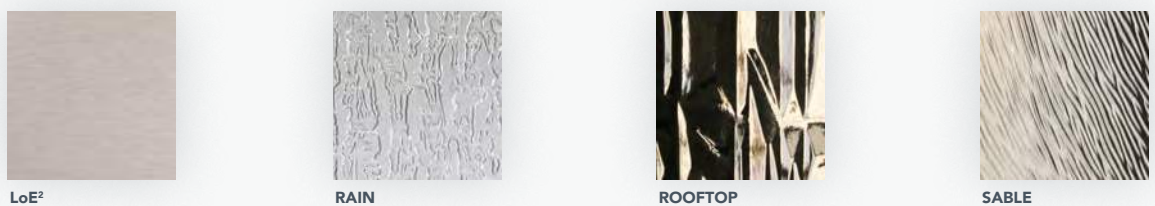

MODERN SMOOTH MARTINIQUE DOOR

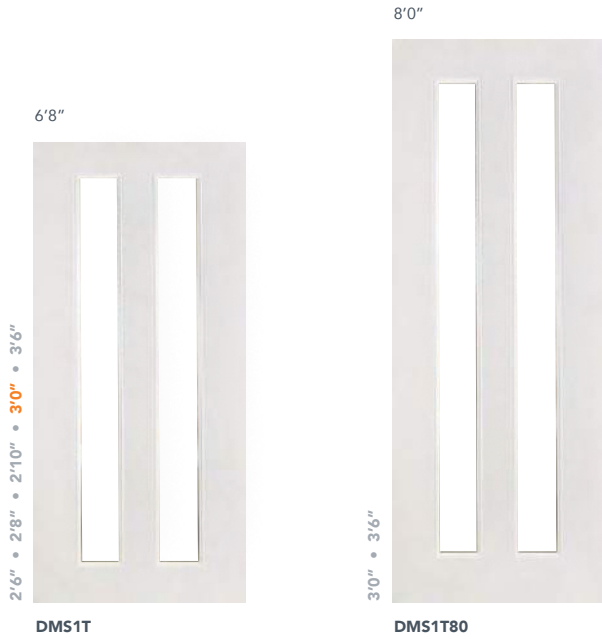

GLASS OPTIONS



MODERN GLASS CLOSE UP

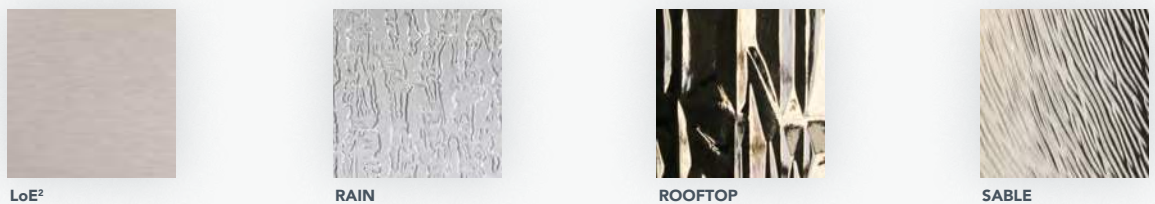

MODERN SMOOTH EMPIRE DOOR

6'8"



2'6" • 2'8" • 2'10" • 3'0"

DMS3H

8'0"



2'6" • 2'8" • 2'10" • 3'0"

DMS3H80

MODERN SMOOTH INFINITY DOOR

6'8"



2'6" • 2'8" • 2'10" • 3'0"

DMS5H

8'0"



2'6" • 2'8" • 2'10" • 3'0"

DMS5H80



Modern Door • DMG46

RUSTIC



Rustic Door DRA2D



Our line of Rustic Doors were designed to provide classic charm, while bringing traditional, upscale appeal to any home. Doors in the Rustic Series display vertical planks, distinct panel details, and arched and radius tops. The Rustic Series only uses wrought iron glass and rustic accessories to reinforce that mid-century rustic look.

ALL RUSTIC DOORS ARE SHOWN PRE-FINISHED

DOOR OVERVIEW

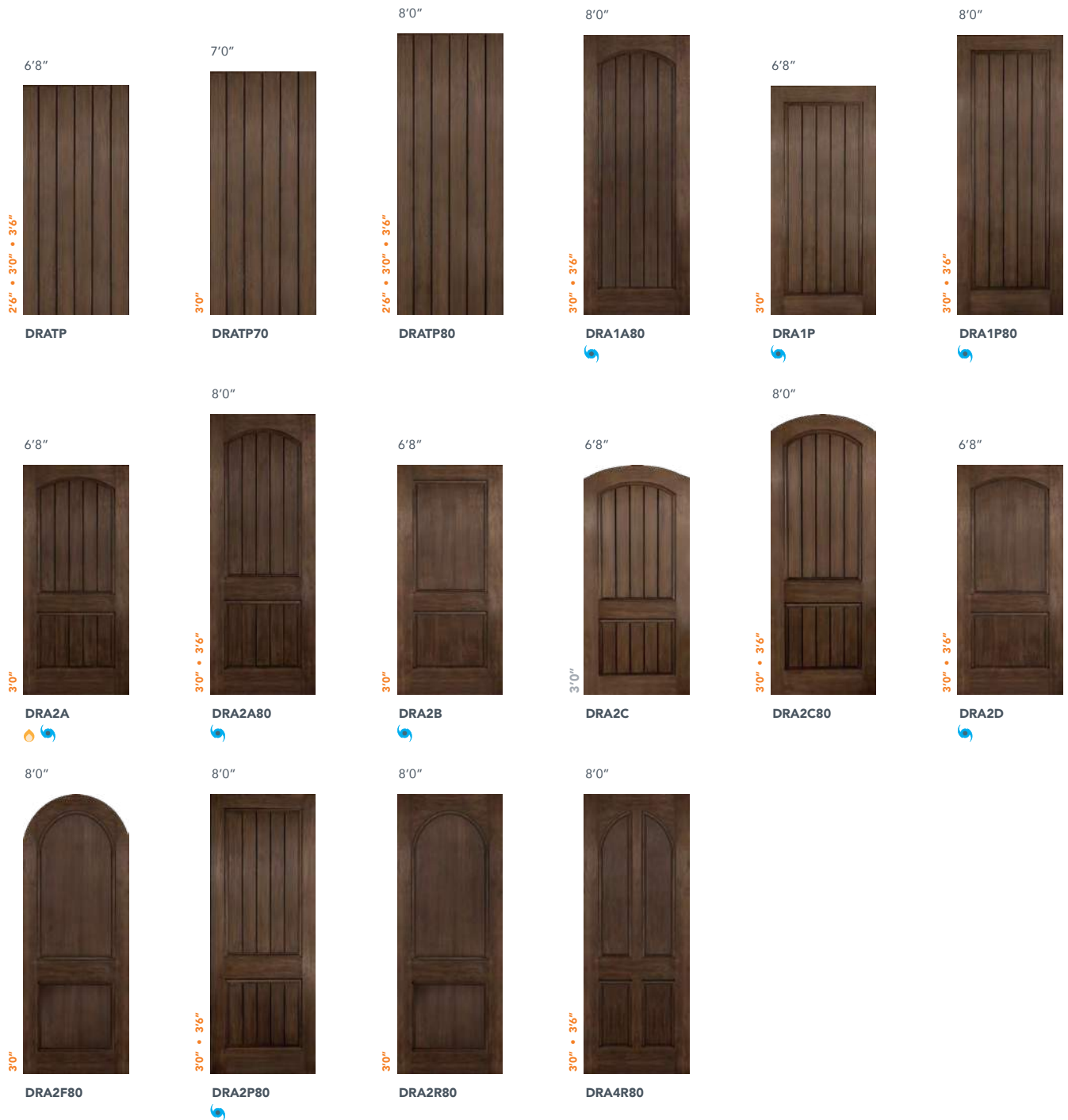

RUSTIC TRUE PLANK DOOR

SQUARE TOP

6'8"



2'6" • 3'0" • 3'6"

DRATP

7'0"



3'0"

DRATP70

8'0"



2'6" • 3'0" • 3'6"

DRATP80

RUSTIC ONE PANEL DOOR

ARCH PLANK & SQUARE TOP

8'0"



3'0" • 3'6"

DRA1A80

RUSTIC ONE PANEL DOOR

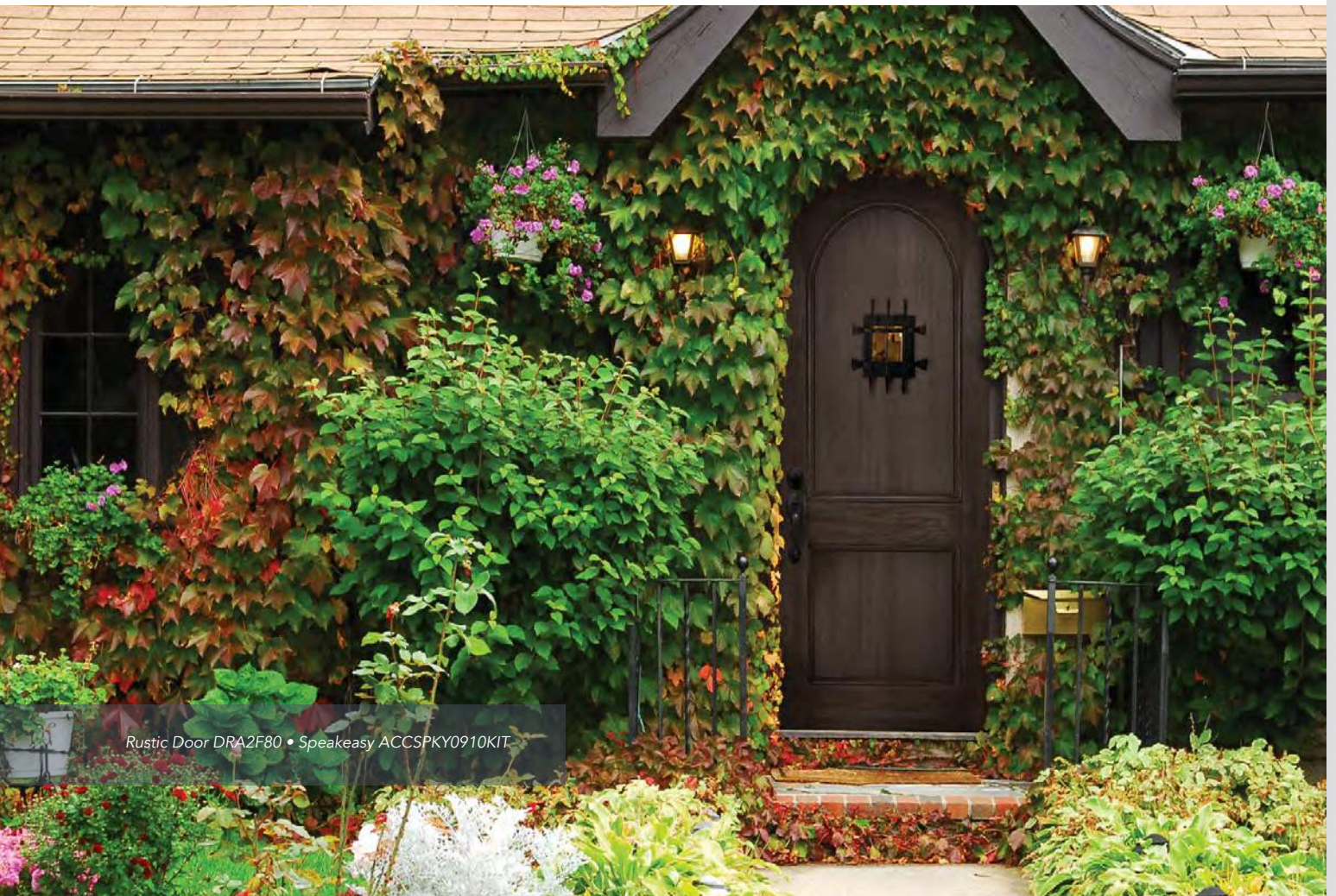

RUSTIC TWO PANEL DOOR

ARCH PLANK & SQUARE TOP

6'8"



3'0"

DRA2A

8'0"



3'0" • 3'6"

DRA2A80



1'0" • 1'2"

SLM6080

GLASS OPTIONS

6'8"



CAM344

6'8"



CAM3R4

6'8"



PCL344

6'8"



PCL3R4

6'8"



CHI344

6'8"



CHI3R4

8'0"



CAM3R5
CAM3R6 (3'6")

8'0"



PCL3R5
PCL3R6 (3'6")

8'0"



CHI3R5
CHI3R6 (3'6")

8'0"



CAMFL2

8'0"



PCLFL2

8'0"

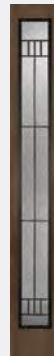

CHIFL2

RUSTIC TWO PANEL DOOR



GLASS OPTIONS



RUSTIC TWO PANEL DOOR

ARCH PLANK & ARCH TOP



GLASS OPTIONS

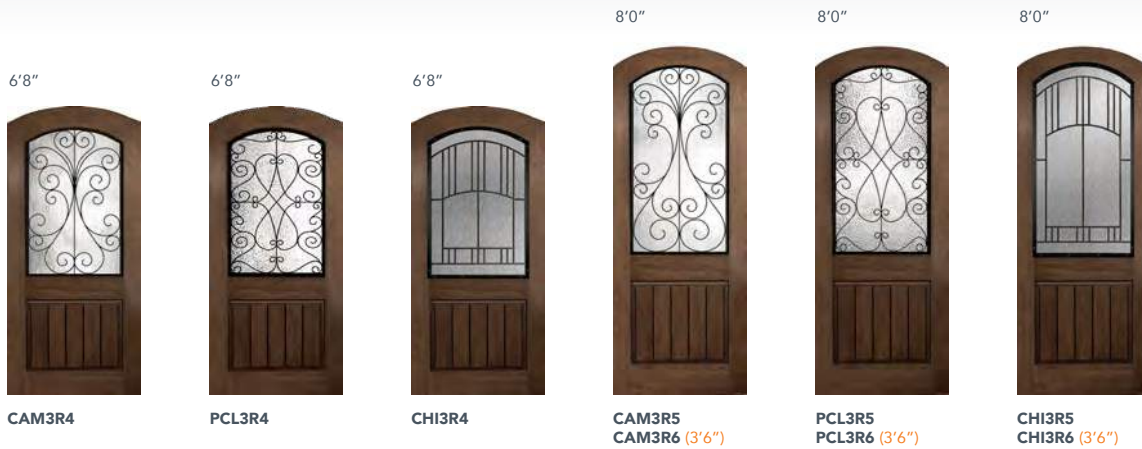

6'8"



3'0" • 3'6"

DRA2D

GLASS OPTIONS

6'8"



CAM3R4

6'8"



PCL3R4

6'8"



CHI3R4

6'8"



CAM344

6'8"



PCL344

6'8"



CHI344

RUSTIC TRUE PLANK DOOR

RADIUS PANEL & RADIUS TOP

8'0"



3'0"

DRA2F80

RUSTIC TWO PANEL DOOR

SQUARE PLANK & SQUARE TOP

8'0"



3'0" • 3'6"

DRA2P80

8'0"



CAMHL6
CAM346 (3'6")

8'0"



PCLHL6
PCL346 (3'6")

8'0"



CHIH6
CHI346 (3'6")

RADIUS PANEL & SQUARE TOP

RUSTIC TWO PANEL DOOR

8'0"



3'0"

DRA2R80

RADIUS PANEL & SQUARE TOP

RUSTIC FOUR PANEL DOOR

8'0"



3'0" • 3'6"

DRA4R80

● IN STOCK

● EXTENDED LEAD TIME



RUSTIC ACCESSORIES

1.5" Square



ACCLP12Q

1.25" Square



ACCLP14Q

1.5" Round



ACCLP12R

1.25" Round



ACCLP14R

DECORATIVE CLAVOS

Plastpro Decorative Clavos provide the perfect accent to some of the most beautiful and highest quality fiberglass doors in the industry. In addition to providing a distinct and unique element to any fiberglass distressed door, our Decorative Clavos enhance our fiberglass entry doors, and provide the perfect "finishing touch" to virtually every Rustic Door we provide.

FEATURES & BENEFITS

- Easy to Apply
- Scientifically Formatted Adhesive Unique for Fiberglass Doors
- Masterfully Crafted Premium Metal Alloy
- Tough and Durable Powder Coat Finish



DRA1P
ACCLP14Q



DRA1P80
ACCLP14Q



DRA2C
ACCLP14R



DRA2C80
ACCLP14R



DRA1A80
ACCLP12Q

● IN STOCK ● EXTENDED LEAD TIME

ACCESSORIES ARE APPLIED BY PLASTPRO DISTRIBUTORS / DEALERS

Speakeasy



ACCSPKY0910KIT

Speakeasy



ACCSPKYGSB0KIT

SPEAKEASY & HINGE STRAP

Plastpro has extended its line of authentic door accessories with the addition of the Hinge Strap and a Speakeasy Kit. Our Hinge Straps and Speakeasy Kit are handcrafted from durable aluminum that resists rust and discoloration. The Speakeasy Kit comes with a distinctive rounded iron grill that enhances the old world styling of our Rustic Door Collection and helps to create a personalized look for your new entry way.

18" Hinge Straps



ACCHGSP18

FEATURES & BENEFITS

- Durable Powder Coat Finish
- Combats Rust and Discoloration
- Beautifully Textured
- Masterfully Handcrafted

View In
6'8"



DRA2D
ACCSPKY0910KIT

View Out
8'0"



DRA2R80
ACCHGSP18
ACCSPKY0910KIT

View In
6'8"



DRA2D
ACCSPKYGSB0KIT

View Out
8'0"



DRA2R80
ACCHGSP18
ACCSPKYGSB0KIT

MAHOGANY



Mahogany Door • DRM4E



The Mahogany Series brings a beloved wood texture into traditional, timeless styles. Our doors come with classic panel designs that can carry all of our decorative glass designs. This series radiates beauty, elegance, and strength to your home.

ALL MAHOGANY DOORS ARE SHOWN PRE-FINISHED

6'8"



3'0"

DRM3D

6'8"



3'0"

DRM4E

6'8"



2'6" • 2'8" • 2'10" • 3'0"

DRM40

6'8"



3'6"

DRM41

6'8"



3'0"

DRM60

8'0"



3'6"

DRM6080

MAHOGANY THREE PANEL DELUXE DOOR

6'8"



3'0"

1'0" • 1'2"

DRM3D

SLM3D

GLASS OPTIONS

6'8"



BRE3V2P/Z

6'8"



CAS3V2P

6'8"



CHR3V2P/Z

6'8"



TAB3V2P

6'8"



BRE3V1P/Z

6'8"



CAS3V1P

6'8"



CHR3V1P/Z

6'8"



TABFL1P

MAHOGANY FOUR PANEL EYEBROW DOOR

6'8"



3'0"

DRM4E

SLM60

1'0" • 1'2"

6'8"



BREEYEP/Z

● IN STOCK

● EXTENDED LEAD TIME



MAHOGANY FOUR PANEL BLANK TOP DOOR

6'8"



DRM40

SLM60

GLASS OPTIONS

6'8"



CASHR1P

6'8"



CHRHR1P/Z

6'8"



TABHR1P

6'8"



CHIHL4
CHIHL3 (2'6")

6'8"



ARTHL4P
ARTHL3P (2'6")

6'8"



ARZHL4Z
ARZHL3Z (2'6")

6'8"



BREHL4P/Z

6'8"



CASHL4P
CASHL3P (2'6")

6'8"



CHRHL4P/Z

6'8"



ELZHL4P
ELZHL3P (2'6")

6'8"



KENHL4P
KENHL3P (2'6")

6'8"



OXFHL4

6'8"



SOLHL4P
SOLHL3P (2'6")

6'8"



SPRHL4P

FOUR PANEL BLANK TOP DOOR

6'8"



TABHL4P
TABHL3P (2'6")

6'8"



MBC/MBLHL4

6'8"



CAMFL7
CAMFL5 (2'6")

6'8"



PCLFL7
PCLFL5 (2'6")

6'8"



CHIFL7
CHIFL5 (2'6")

6'8"

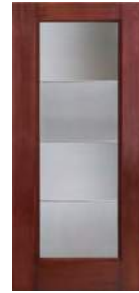

ABRFL7Z
ABRFL5Z (2'6")

6'8"



ARTFL7P
ARTFL5P (2'6")

6'8"



ARZFL7Z
ARZFL5Z (2'6")

6'8"



BREFL7P/Z

6'8"



CASFL7P
CASFL5P (2'6")

6'8"



CHRHFL7P/Z

6'8"



ELZFL7P
ELZFL5P (2'6")

6'8"



KENFL7P
KENFL5P (2'6")

6'8"



OXFFL7

6'8"



SOLFL7P
SOLFL5P (2'6")

6'8"



SPRFL7P

6'8"



TABFL7P
TABFL5P (2'6")

6'8"



MBC/MBLFL7
MBC/MBLFL5 (2'6")

6'8"



CHIHL2

6'8"



ARTHL2P

6'8"



ARZHL2Z

6'8"



BREHL2P/Z

6'8"



CASHL2P

6'8"



CHRHL2P/Z

6'8"

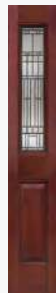

ELZHL2P

FOUR PANEL BLANK TOP DOOR

6'8"



KENHL2P

6'8"



OXFHL2

6'8"

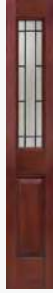

SOLHL2P

6'8"



SPRHL2P

6'8"



MBC/MBLHL2

6'8"



CAMFL1

6'8"



PCLFL1

6'8"



CHIFL1

6'8"



ABRFL1Z

6'8"



ARTFL1P

6'8"



ARZFL1Z

6'8"



BREFL1P/Z

6'8"



CASFL1

6'8"



CHRFL1P/Z

6'8"



ELZFL1P

6'8"



KENFL1P

6'8"



OXFFL1

6'8"



SOLFL1P

6'8"

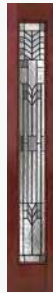

SPRFL1P

6'8"

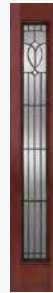

TABFL1P

6'8"



MBC/MBLFL1

MAHOGANY TRUE FOUR PLANK DOOR

6'8"



3'6"

DRM41

MAHOGANY SIX PANEL DOOR



GLASS OPTIONS

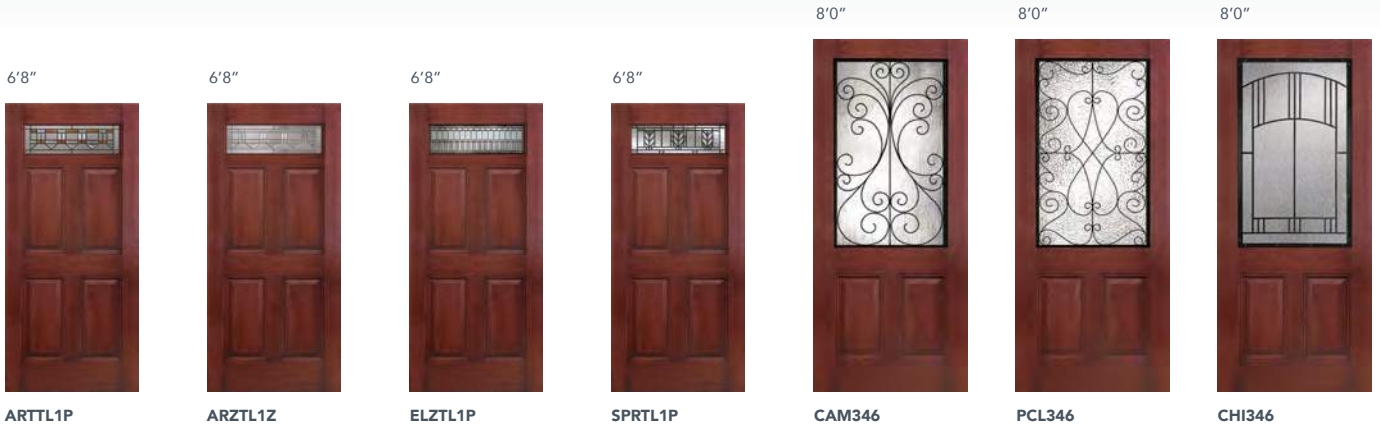



Mahogany Door • DRM60 • Glass ARTTL1P

FIR GRAIN



Fir Grain Door DRF3C • Glass G000 • Accessory ACSD23006



Our Fir Grain Series has straight, fine vertical graining that produces outstanding results. Accessorized with: simulated divided lights (SDL) and a dentil shelf, it's no surprise it's become a favorite. These fir doors create fine details and give your home a traditional, craftsman appeal.

ALL FIR GRAIN DOORS ARE SHOWN PRE-FINISHED



SHAKER PROFILE DOORS



● COMING SOON - PLEASE CALL REGARDING AVAILABILITY 🔥 20 MIN FIRE RATED 📏 10" BOTTOM RAIL ● IN STOCK ● EXTENDED LEAD TIME



FIR GRAIN CRAFTSMAN DOOR

DIRECT GLAZED

DRF3C & DRF3C80 & MATCHING SIDELITES ARE ONLY AVAILABLE WITH GLASS



GLASS OPTIONS



● IN STOCK ● EXTENDED LEAD TIME ● EXTENDED LEAD TIME

8'0"



SOLP

8'0"



SPRP

6'8"



G000

8'0"



G000

8'0"



B01P

8'0"



B02P

8'0"



ARTP

8'0"



ARZZ

8'0"



KENP

8'0"



SOLP

8'0"



SPRP

6'8"



6'8"



FIR GRAIN SHAKER DOOR

ONE PANEL SQUARE TOP

6'8"



2'8" • 2'10" • 3'0"

DRF1K



SHAKER PROFILE

The straightforward shaker design showcases the beauty that minimal design can offer. Our shaker focuses on simplicity and is easily adaptable for any home's exterior.

FIR GRAIN 2 PANEL SHAKER DOOR

6'8"



2'8" • 2'10" • 3'0"

DRF2K

FIR GRAIN SHAKER CRAFTSMAN DOOR



FIR GRAIN 5 PANEL SHAKER DOOR





Fir Grain Door DRF3C • Glass G000 • SDL ACSDf23006 • Dentil Shelf ACDSfT2704

FIR GRAIN ACCESSORIES



3 Lite



6'8" ACSDF/23001
8'0" ACSDF/23005

SIMULATED DIVIDED LIGHTS "SDL" BARS

Plastpro Simulated Divided Lights (SDL Bars) can be used on the interior and exterior of our doors and help create personalized, unique looks. They are easy to install and will not rot or absorb moisture.

6 Lite



6'8" ACSDF/23002
8'0" ACSDF/23006

Sidelite



ACSDF/23004

FEATURES & BENEFITS

- Easy installation using common wood working tools and equipment.
- Will not rot or absorb moisture and resists the growth of fungus and mildew.
- Closed cellular structure prevents paint from peeling off the surface.
- Will not warp or crack when properly installed, or be affected by UV rays when properly coated.

4 Block Dentil Shelf



ACDSFT2704

DENTIL SHELF

Plastpro Dentil Shelves are made of lightweight High Density Polyurethane (HDP) and will not warp, rot, or crack. HDP is an excellent alternative to traditional wood products.

FEATURES & BENEFITS

- Recreate Classic Design
- Create Custom Looks
- Affordable































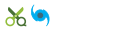















OAK GRAIN



Dressed in a rich oak grain texture, our Oak series gives a classic look to your home. Oak doors come in many panel designs. Mix and match these styles with our entire glass line to find the combination that best brings out your homes unique characteristics. These doors create a timeless look that will never go out of style.

ALL OAK GRAIN DOORS ARE SHOWN PRE-FINISHED

DOOR OVERVIEW

<p>6'8"</p>  <p>2'0" • 2'4" • 2'6" • 2'8" • 2'10" • 3'0" • 3'6"</p> <p>DRG00</p> 	<p>7'0"</p>  <p>2'0" • 2'4" • 2'6" • 2'8" • 2'10" • 3'0" • 3'6"</p> <p>DRG0070</p> 	<p>8'0"</p>  <p>2'0" • 2'4" • 2'6" • 2'8" • 2'10" • 3'0" • 3'6"</p> <p>DRG0080</p> 	<p>6'8"</p>  <p>3'0"</p> <p>DRG20</p> 	<p>8'0"</p>  <p>6'8"</p> <p>2'8" • 2'10" • 3'0"</p> <p>DRG29 DRG2980</p> 	<p>6'8"</p>  <p>3'0"</p> <p>DRG3E</p> 
<p>6'8"</p>  <p>3'0"</p> <p>DRG3P</p> 	<p>8'0"</p>  <p>2'8" • 3'0" • 3'6"</p> <p>DRG3080</p> 	<p>6'8"</p>  <p>7'0"</p> <p>3'0" (3'0" in 7'0" extended lead time)</p> <p>DRG31 DRG3170</p> 	<p>6'8"</p>  <p>2'6" • 2'8" • 2'10" • 3'0"</p> <p>DRG40</p> 	<p>6'8"</p>  <p>2'8" • 3'0"</p> <p>DRG41</p> 	<p>7'0"</p>  <p>3'0"</p> <p>DRG4170</p> 
<p>8'0"</p>  <p>2'8" • 3'0"</p> <p>DRG4180</p> 	<p>6'8"</p>  <p>2'8" • 2'10" • 3'0"</p> <p>DRG49</p> 	<p>6'8"</p>  <p>3'0"</p> <p>DRG6B</p> 	<p>6'8"</p>  <p>3'0"</p> <p>DRG6C</p> 	<p>8'0"</p>  <p>6'8"</p> <p>2'6" • 3'0" (2'8" & 3'6" avail in 8'0" only)</p> <p>DRG60 DRG6080</p> 	<p>6'8"</p>  <p>2'8" • 3'0"</p> <p>DRG61</p> 
<p>7'0"</p>  <p>2'8" • 2'10" • 3'0"</p> <p>DRG6170</p> 	<p>8'0"</p>  <p>2'8" • 2'10" • 3'0"</p> <p>DRG6180</p> 	<p>6'8"</p>  <p>2'8" • 2'10" • 3'0"</p> <p>DRG63</p> 	<p>8'0"</p>  <p>6'8"</p> <p>3'0" • (3'6" available only in 8' Door)</p> <p>DRG80 DRG8080</p> 	<p>6'8"</p>  <p>2'8" • 3'0"</p> <p>DRG90</p> 	<p>8'0"</p>  <p>3'0"</p> <p>DRG9180</p> 

OAK GRAIN FLUSH PANEL DOOR

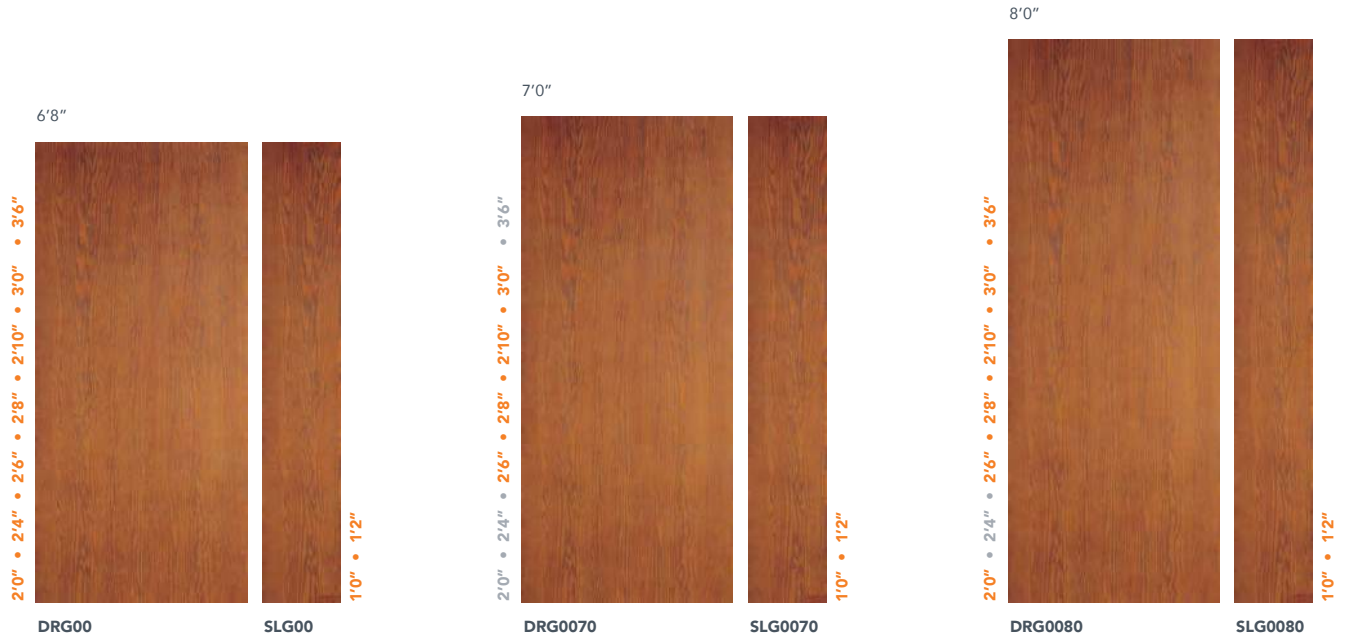

GLASS OPTIONS

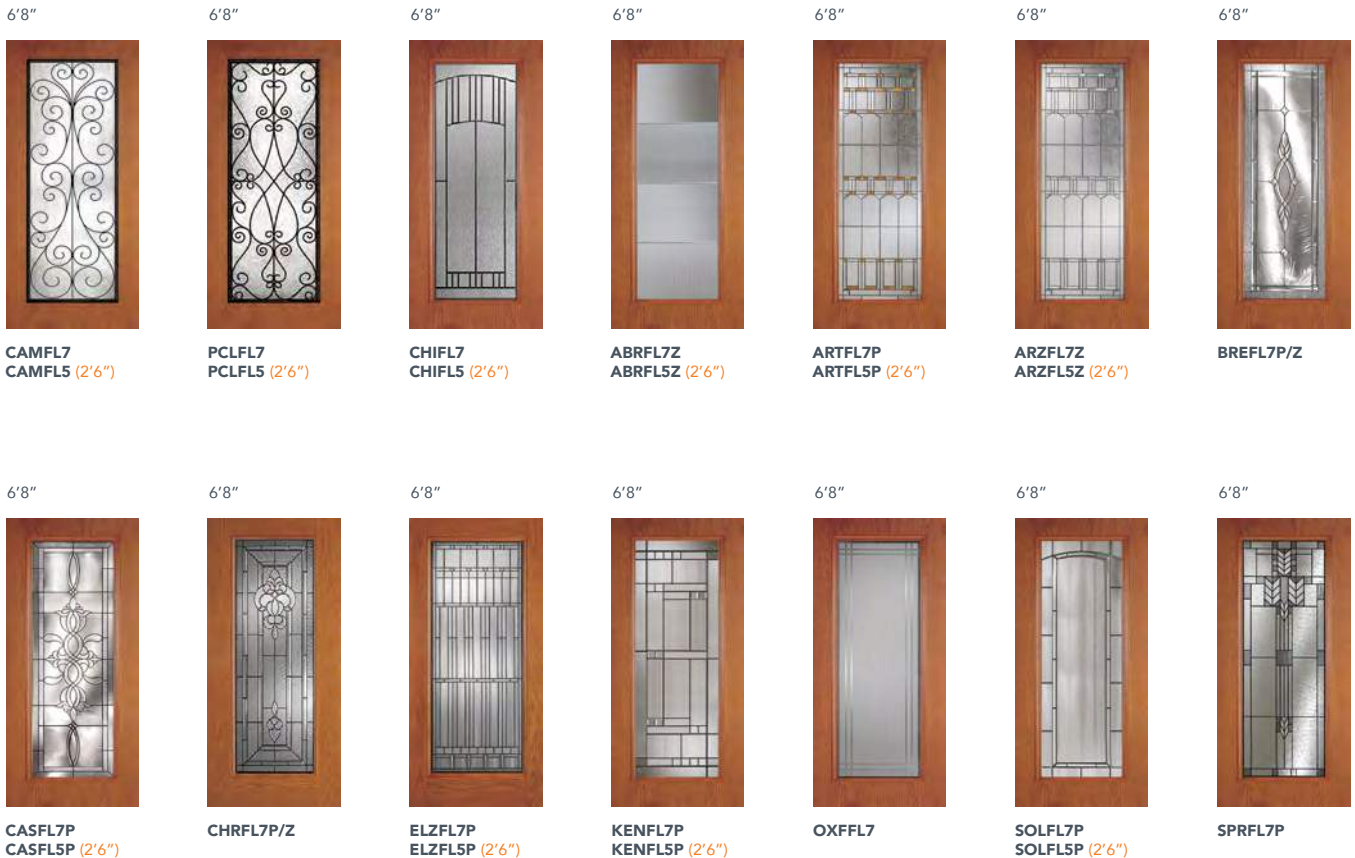

● IN STOCK ● EXTENDED LEAD TIME

OAK GRAIN FLUSH PANEL DOOR

6'8"



TABFL7P
TABFL5P (2'6")

6'8"



MBC/MBLFL7
MBC/MBLFL5 (2'6")

7'0"



CAMFL7
CAMFL5 (2'6")

7'0"



PCLFL7
PCLFL5 (2'6")

7'0"



CHIFL7
CHIFL5 (2'6")

7'0"



ABRFL7Z
ABRFL5Z (2'6")

7'0"



ARTFL7P
ARTFL5P (2'6")

7'0"



ARZFL7Z
ARZFL5Z (2'6")

7'0"



BREFL7P/Z
BREFL5P/Z (2'6")

7'0"



CASFL7P
CASFL5P (2'6")

7'0"



CHRFL7P/Z

7'0"



ELZFL7P
ELZFL5P (2'6")

7'0"



KENFL7P
KENFL5P (2'6")

7'0"



OXFFL7

7'0"



SOLFL7
SOLFL5 (2'6")

7'0"



SPRFL7

7'0"



TABFL7P
TABFL5P (2'6")

7'0"



MBC/MBLFL7
MBC/MBLFL5 (2'6")

8'0"



CAMFL8
CAMFL6 (2'6")

8'0"



PCLFL8
PCLFL6 (2'6")

8'0"



CHIFL8
CHIFL6 (2'6")

8'0"



ABRFL8Z
ABRFL6Z (2'6")

8'0"



ARTFL8P

8'0"

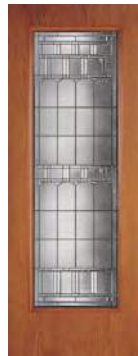

ARZFL8Z

8'0"



BREFL8P/Z

8'0"



CASFL8P

8'0"



ELZFL8P
ELZFL6P (2'6")

8'0"



KENFL8P

OAK GRAIN FLUSH PANEL DOOR

8'0"



OXFL8

8'0"



SOLFL8P

8'0"



TABFL8P

8'0"



MBC/MBFL8
MBC/MBFL6 (2'6")

8'0"



CAMFL1 & FL2

8'0"



PCLFL1 & FL2

8'0"



CHIFL1 & FL2

8'0"



ABRFL1Z & FL2Z

8'0"



ARTFL1P & FL2P

8'0"



ARZFL1Z & FL2Z

8'0"



BREFL1P/Z
& FL2P/Z

8'0"



CASFL1P & FL2P

8'0"

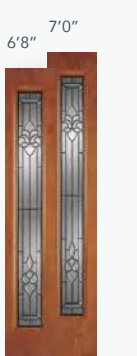

CHRFL1P/Z

8'0"



ELZFL1P & FL2P

8'0"



KENFL1P & FL2P

8'0"



OXFL1 & FL2

8'0"



SOLFL1P & FL2P

8'0"



SPRFL1P & FL2P

8'0"



TABFL1P & FL2P

8'0"



MBC/MBFL1 & FL2



OAK GRAIN 3/4 HERITAGE DOOR

6'8"



DRG20



SLG3E

3'0"

1'0" • 1'2"

GLASS OPTIONS

6'8"



BRE3V2P/Z

6'8"



CAS3V2P

6'8"



CHR3V2P/Z

6'8"



TAB3V2P

6'8"

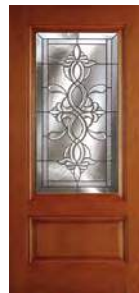

CAS343P

6'8"



BRE341P/Z

6'8"



CAS341P

6'8"



CHR341P/Z

6'8"



TAB341P

OAK GRAIN 3/4 TWO PANEL DOOR



GLASS OPTIONS

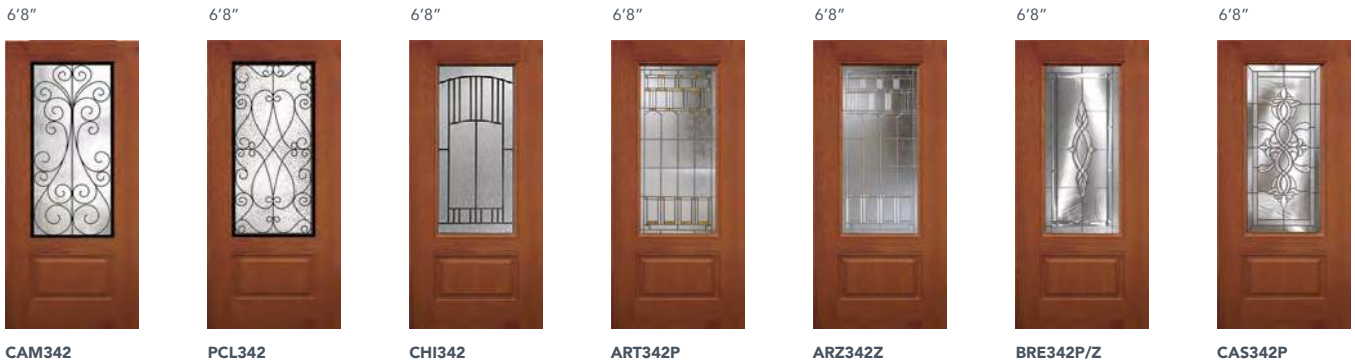

● IN STOCK ● EXTENDED LEAD TIME

3/4 TWO PANEL DOOR

8'0"



CAMFL7

8'0"



PCLFL7

8'0"



CHIFL7

8'0"



ABRFL7Z

8'0"



ARTFL7P

8'0"



ARZFL7Z

8'0"



BRFL7P/Z

8'0"



CASFL7P

8'0"



CHRFL7P/Z

8'0"



ELZFL7P

8'0"



KENFL7P

8'0"



OXFFL7

8'0"



SOLFL7P

8'0"



SPRFL7P

8'0"



TABFL7P

8'0"



MBC/MBLFL7

8'0"



CAMFL1

8'0"



PCLFL1

8'0"



CHIFL1

8'0"



ABRFL12

8'0"

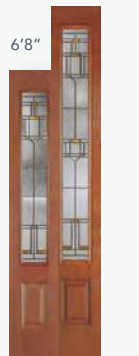

ART341P & FL1P

8'0"

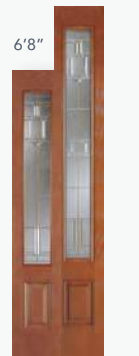

ARZ341Z & FL1Z

8'0"

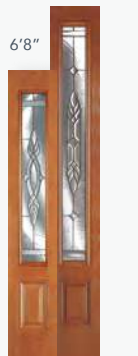

BRE341P/Z & FL1P/Z

3/4 TWO PANEL DOOR



CAS341 & FL1P



CHR341P/Z & FL1P/Z



ELZ341P & FL1P



KEN341 & FL1



OXF341 & FL1



SOL341P & FL1P



SPR341P & FL1P



TAB341P & FL1P



MBC/MBLFL1



OAK GRAIN 3/4 ELITE DOOR

6'8"



30"

10" • 12"

DRG3E

SLG3E

GLASS OPTIONS

6'8"



BRE3V2P/Z

6'8"



CAS3V2P

6'8"



CHR3V2P/Z

6'8"



TAB3V2P

6'8"

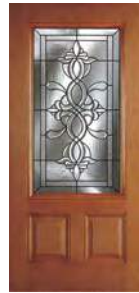

CAS343P

6'8"



BREFL1P/Z

6'8"



CAS341P

6'8"



CHR341P/Z

6'8"



TAB341P

OAK GRAIN 3/4 PREMIUM DOOR

6'8"



DRG3P



SLG3P

3'0"

1'0" • 1'2"

GLASS OPTIONS

6'8"



BRE3V2P/Z

6'8"



CAS3V2P

6'8"



CHR3V2P/Z

6'8"



TAB3V2P

6'8"



BRE3V1P/Z

6'8"



CAS3V1P

6'8"



CHR3V1P/Z

OAK GRAIN 3/4 PANEL DOOR

8'0"



2'8" • 3'0" • 3'6"

1'0" • 1'2"

DRG3080

SLG3080

GLASS OPTIONS

8'0"



BRE3V3P/Z

8'0"



CAS3V3P

8'0"



CAMFL7

8'0"



PCLFL7

8'0"

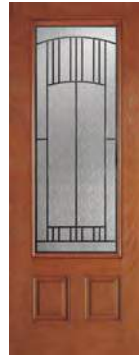

CHIFL7

8'0"



ABRFL7Z

8'0"



ARTFL7P

8'0"



ARZFL7Z

8'0"



BREFL7P/Z

8'0"



CASFL7P

8'0"



CHRFL7P/Z

8'0"



ELZFL7P

8'0"



KENFL7P

8'0"



OXFFL7

3/4 THREE PANEL DOOR

8'0"



SOLFL7P

8'0"



SPRFL7P

8'0"



TABFL7P

8'0"



MBC/MBLFL7

8'0"



CAMFL1

8'0"



PCLFL1

8'0"



CHILFL1

8'0"



ABRFL1Z

8'0"



ARTFL1P

8'0"



ARZFL1Z

8'0"

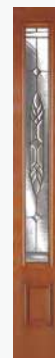

BREFL1P/Z

8'0"



CASFL1P

8'0"



CHRFL1P/Z

8'0"



ELZFL1P

8'0"



KENFL1P

8'0"



OXFFL1

8'0"



SOLFL1P

8'0"



SPRFL1P

8'0"



TABFL1P

8'0"



MBC/MBLFL1

OAK GRAIN THREE PANEL DOOR

6'8"



3'0"

DRG31

7'0"



3'0"

DRG3170

OAK GRAIN FOUR PANEL BLANK TOP DOOR



GLASS OPTIONS



CASHR1P



CHRR1P/Z



TABHR1P



CHIHL4



ARTHL4P



ARZHL4Z



BREHL4P/Z



CASHL4P

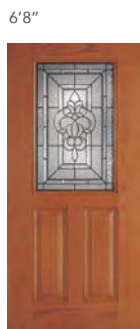

CHRH4P/Z



ELZHL4P



KENHL4P



OXFHL4



SOLHL4P

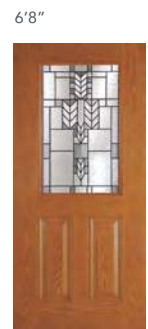

SPRHL4P

● IN STOCK ● EXTENDED LEAD TIME

FOUR PANEL BLANK TOP DOOR

6'8"



TABHL4P

6'8"



MBC/MBLHL4

6'8"



CHIHL2

6'8"



ARTHL2P

6'8"



ARZHL2Z

6'8"



BREHL2P/Z

6'8"



CASHL2P

6'8"

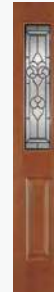

CHRHL2P/Z

6'8"

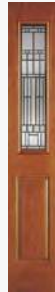

ELZHL2P

6'8"



KENHL2P

6'8"



OXFHL2

6'8"



SOLHL2P

6'8"



SPRHL2P

6'8"



TABFL1P

6'8"



MBC/MBLHL2



Oak Grain Door • DRG6080

OAK GRAIN TRUE FOUR PANEL DOOR



GLASS OPTIONS



● IN STOCK ● EXTENDED LEAD TIME

TRUE FOUR PANEL DOOR

7'0"



ARTHL4P

7'0"



ARZHL4Z

7'0"



BREHL4P/Z

7'0"



CASHL4P

7'0"



CHRHL4P

7'0"



ELZHL4P

7'0"



KENHL4P

7'0"



OXFHL4

7'0"



SOLHL4P

7'0"



SPRHL4P

7'0"



TABHL4P

7'0"



MBC/MBLHL4

8'0"



CAM342

8'0"



PCL342

8'0"



CHI342

8'0"



ART342P

8'0"



ARZ342Z

8'0"



BRE342P/Z

8'0"



CAS342P

8'0"



CHR342P

8'0"



ELZ342P

8'0"



KEN342P

8'0"



OXF342

8'0"



SOL342P

8'0"



SPR342P

8'0"



TAB342P

TRUE FOUR PANEL DOOR



CHIHL2



ARTH2P & 341P



ARZHL2Z & 341Z



BREHL2P/Z & 341P/Z



CASHL2P & 341P



CHRHL2P/Z & 341P/Z



ELZHL2P & 341P



KENHL2P & 341P



OXFHL2 & 341



SOLHL2P & 341P



SPRHL2P & 341P



TABFL1P & 341P



MBC/MCLHL2

OAK GRAIN 3/4 FOUR PANEL DOOR



GLASS OPTIONS

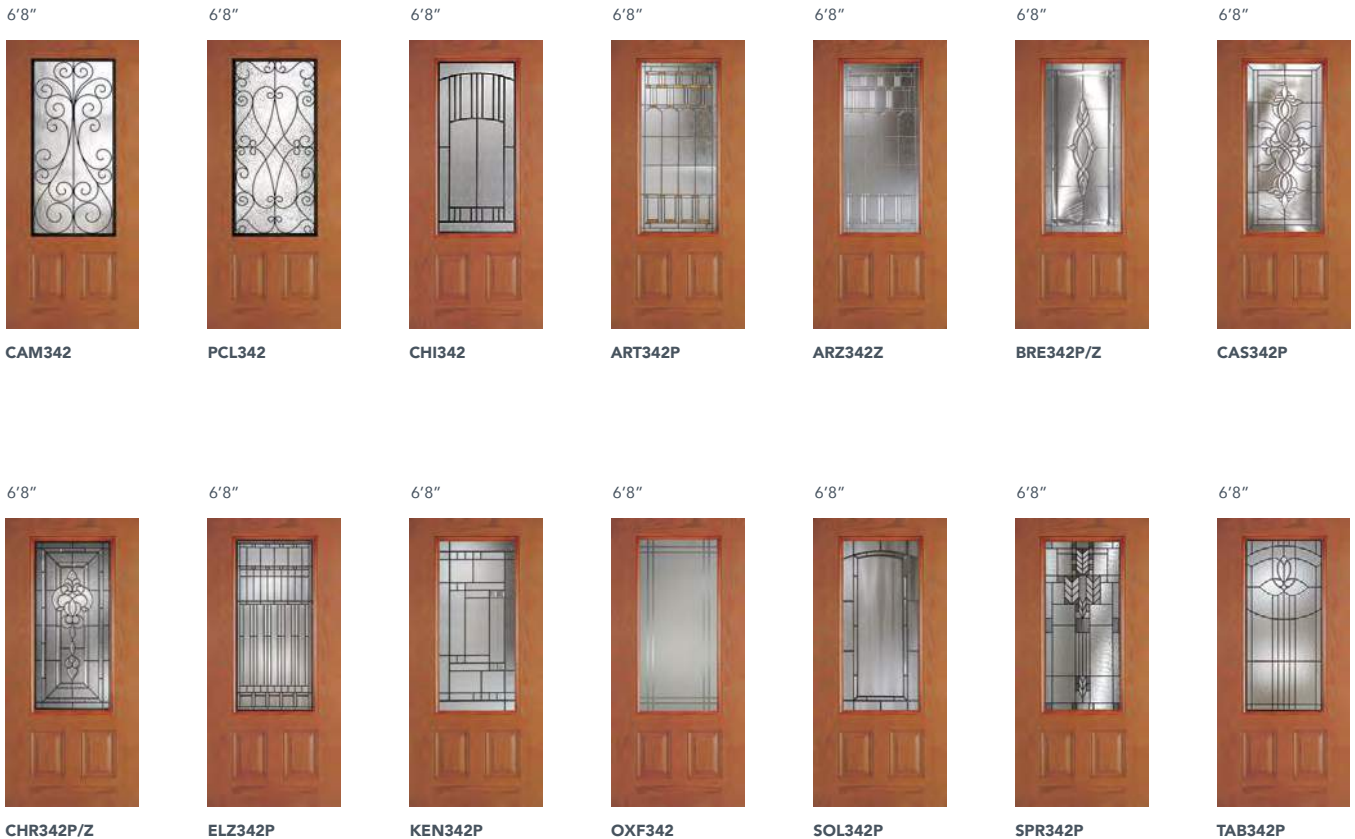

● IN STOCK ● EXTENDED LEAD TIME

3/4 FOUR PANEL DOOR

DESCRIPTION

6'8"



ART341P

6'8"



ARZ341Z

6'8"



BRE341P/Z

6'8"



CAS341P

6'8"



CHR341P/Z

6'8"

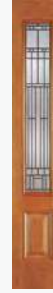

ELZ341P

6'8"



KEN341P

6'8"



OXF341

6'8"



SPR341P

6'8"



SOL341P

6'8"



TAB341P

OAK GRAIN SIX PANEL CRAFTSMAN DOOR

6'8"



3'0"

DRG6C



OAK GRAIN ACCESSORIES AVAILABLE ON PAGE 107.

GLASS OPTIONS

6'8"



ARTTL3P

6'8"



ARZTL3Z

6'8"



BRETL3P/Z

6'8"



ELZTL3P

6'8"



OXFTL3

6'8"



SOLTL3P

6'8"



SPRTL3P

OAK GRAIN SIX PANEL DOOR



GLASS OPTIONS

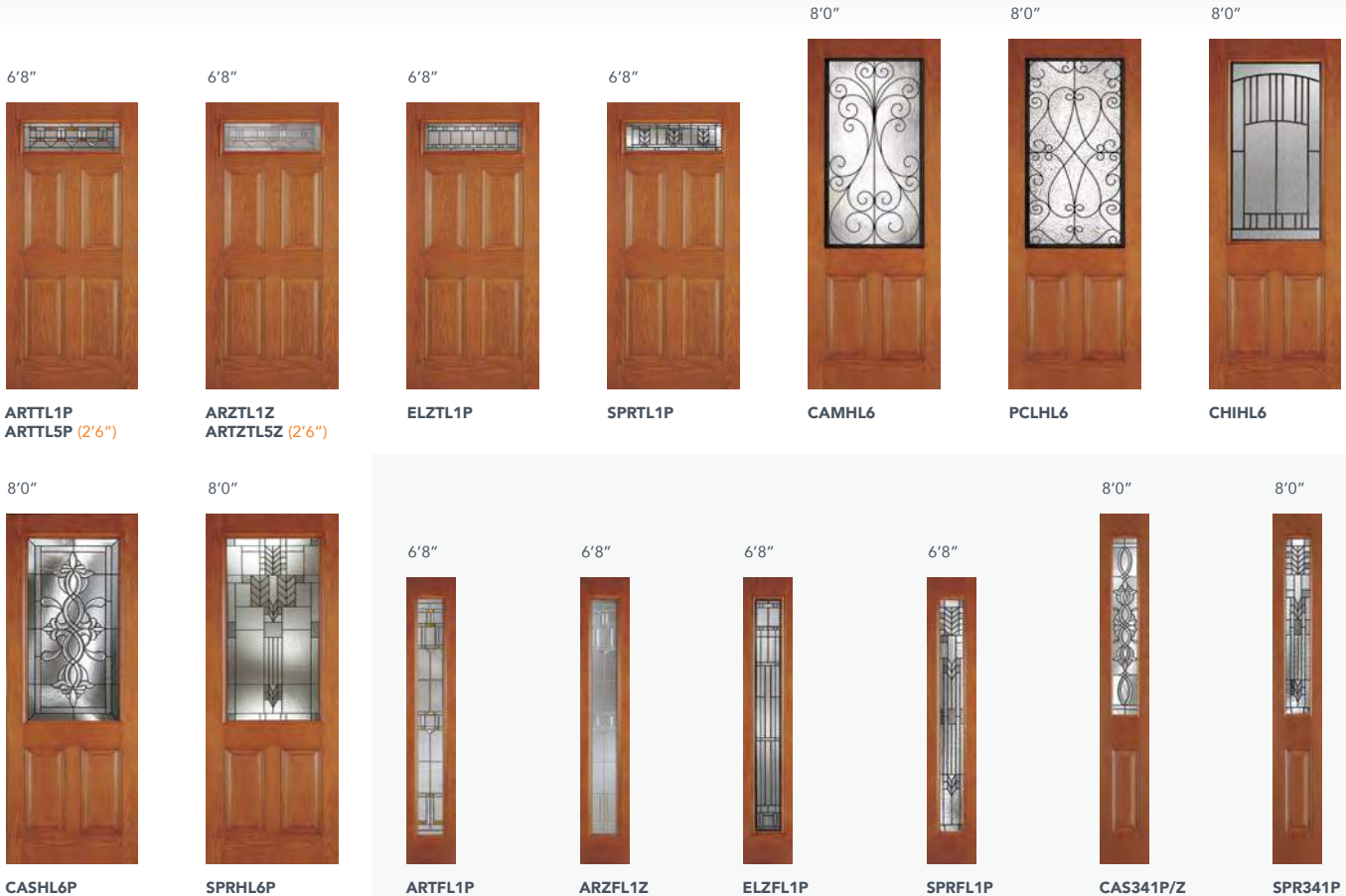

● IN STOCK ● EXTENDED LEAD TIME

OAK GRAIN SIX PANEL UTILITY DOOR



GLASS OPTIONS



● IN STOCK ● EXTENDED LEAD TIME

SIX PANEL UTILITY DOOR

7'0"



ARTHL4P

7'0"



ARZHL4Z

7'0"



BREHL4P/Z

7'0"



KENHL4P

7'0"



OXFHL4

7'0"



SOLHL4P

7'0"



SPRHL4P

7'0"



TABHL4P

7'0"



MBC/MBLHL4

8'0"



CHI342

8'0"



ART342P

8'0"



ARZ342Z

8'0"



BRE342P/Z

8'0"



CAS342P

8'0"



CHR342P/Z

8'0"



ELZ342P

8'0"



KEN342P

8'0"



OXF342

8'0"



SOL342P

8'0"



SPR342P

8'0"



TAB342P

6'8" 7'0"



CHIHL2

6'8" 7'0"



ARTHL2P

6'8" 7'0"



ARZHL2Z

6'8" 7'0"



BREHL2P/Z

6'8" 7'0"



CASHL2P

6'8" 7'0"



CHRHL2P/Z

6'8" 7'0"



ELZHL2P

SIX PANEL UTILITY DOOR



KENHL2P



OXFHL2



SOLHL2P



SPRHL2P



TABFL1P



MBC/MBLHL2P

Oak Grain Door • DRG3E • Glass CHI342



OAK GRAIN TRUE SIX PANEL NARROW DOOR

6'8"



2'8" • 2'10" • 3'0"

1'0" • 1'2"

DRG63

SLG60

GLASS OPTIONS

6'8"



CHIHL4

6'8"



ARTHL4P

6'8"



ARZHL4Z

6'8"

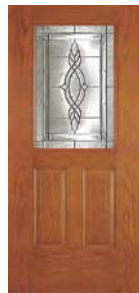

BREHL4P/Z

6'8"

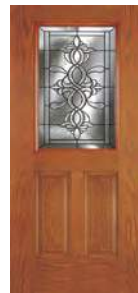

CASHL4P

6'8"



CHRHL4P/Z

6'8"



ELZHL4P

6'8"



KENHL4P

6'8"



OXFHL4

6'8"



SOLHL4P

6'8"



SPRHL4P

6'8"



TABHL4P

6'8"



MBC/MBLHL4

TRUE SIX PANEL NARROW DOOR

6'8"



CHIHL2P

6'8"



ARTHL2P

6'8"



ARZHL2Z

6'8"



BREHL2ZP/Z

6'8"



CASHL2P

6'8"



CHRL2ZP/Z

6'8"

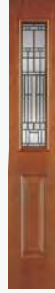

ELZHL2P

6'8"



KENHL2P

6'8"



OXFHL2

6'8"

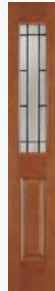

SOLHL2P

6'8"



SPRHL2P

6'8"



TABFL1

6'8"



MBC/MBLHL2

OAK GRAIN EIGHT PANEL DOOR



GLASS OPTIONS



OAK GRAIN NINE PANEL DOOR

6'8"



2'8" • 3'0"

DRG90

6'8"



BRE9P1F/Z

6'8"



SPR9P1P

GLASS OPTIONS

● IN STOCK

● EXTENDED LEAD TIME



Oak Grain Door • DRG80 • Glass ART8C2P

OAK GRAIN NINE PANEL DOOR

8'0"



3'0"

DRG9180

GLASS OPTIONS

8'0"



ART341P

8'0"



ARZ341Z

8'0"



BRE341P/Z

8'0"



CAS341P

8'0"



CHR341P/Z

8'0"



ELZ341P

8'0"



KEN341P

8'0"



OXF341

8'0"



SOL341P

8'0"



SPR341P

8'0"



TAB341P

OAK GRAIN ACCESSORIES



4 Block Dentil Shelf



ACDSGT2704

DENTIL SHELF

Plastpro Dentil Shelves are made of lightweight High Density Polyurethane (HDP) and will not warp, rot, or crack. HDP is an excellent alternative to traditional wood products.

16 Block Dentil Shelf



ACDSGT2716

FEATURES & BENEFITS

- Recreate Classic Design
- Create Custom Looks
- Affordable

6'8"



DRG6C
ARTTL3P
ACDSGT2704

6'8"



DRG6C
BRETLL3Z
ACDSGT2716

6'8"



DRG6C
ELZTL3P
ACDSGT2704

6'8"



DRG6C
SOLTL3P
ACDSGT2716

6'8"



DRG6C
SPRTL3P
ACDSGT2704

















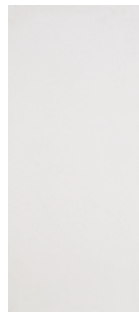







































SMOOTH

































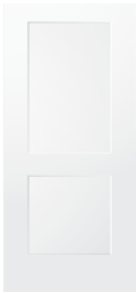

Smooth Door • DRS3E

Our Smooth Doors are made with a pre-pigmented white skin; its simplicity gives a modern design and feel to any home. Our Smooth skin incorporated with a variety of panel designs and glass options, gives a clean, minimal look to any of our fiberglass doors.

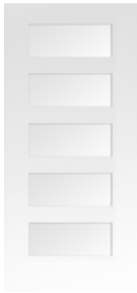
DOOR OVERVIEW

<p>6'8"</p>  <p>2'0" • 2'4" • 2'6" • 2'8" • 2'10" • 3'0" • 3'6"</p> <p>DRS500</p>    	<p>7'0"</p>  <p>2'0" • 2'4" • 2'6" • 2'8" • 2'10" • 3'0" • 3'6"</p> <p>DRS0070</p>    	<p>8'0"</p>  <p>2'0" • 2'4" • 2'6" • 2'8" • 2'10" • 3'0" • 3'6"</p> <p>DRS0080</p>    	<p>6'8"</p>  <p>2'8" • 2'10" • 3'0"</p> <p>DRS2B</p>  	<p>8'0"</p>  <p>2'8" • 2'10" • 3'0"</p> <p>DRS2B80</p> 	<p>6'8"</p>  <p>2'8" • 2'10" • 3'0"</p> <p>DRS2D</p>  
<p>8'0"</p>  <p>2'8" • 2'10" • 3'0"</p> <p>DRS2D80</p> 	<p>6'8"</p>  <p>2'8" • 2'10" • 3'0"</p> <p>DRS2G</p>  	<p>8'0"</p>  <p>2'8" • 2'10" • 3'0"</p> <p>DRS2G80</p> 	<p>6'8"</p>  <p>3'0"</p> <p>DRS20</p>	<p>6'8"</p>  <p>2'8" • 2'10" • 3'0"</p> <p>DRS29</p> 	<p>8'0"</p>  <p>2'8" • 2'10" • 3'0"</p> <p>DRS2980</p> 
<p>6'8"</p>  <p>3'0" (Only available with glass)</p> <p>DRS3C</p>	<p>8'0"</p>  <p>3'0" (Only available with glass)</p> <p>DRS3C80</p>	<p>6'8"</p>  <p>3'0"</p> <p>DRS3E</p>	<p>6'8"</p>  <p>3'0"</p> <p>DRS3P</p> 	<p>8'0"</p>  <p>2'8" • 3'0" • 3'6"</p> <p>DRS3080</p> 	<p>6'8"</p>  <p>3'0"</p> <p>DRS31</p> 
<p>7'0"</p>  <p>3'0"</p> <p>DRS3170</p> 	<p>6'8"</p>  <p>2'8" • 2'10" • 3'0"</p> <p>DRS40</p> 	<p>6'8"</p>  <p>2'8" • 3'0"</p> <p>DRS41</p>  	<p>7'0"</p>  <p>3'0"</p> <p>DRS4170</p>  	<p>8'0"</p>  <p>2'8" • 3'0"</p> <p>DRS4180</p>	<p>6'8"</p>  <p>2'6"</p> <p>DRS42</p>

DOOR OVERVIEW

6'8"	6'8"	6'8"	6'8"	8'0"	6'8"
					
2'8" • 2'10" • 3'0"	2'8" • 2'10" • 3'0"	3'0"	2'6" • 3'0"	2'6" • 2'8" • 3'0"	2'8" • 2'10" • 3'0"
DRS49 	DRS6B 	DRS6C	DRS60   	DRS6080 	DRS61  
7'0"	8'0"	6'8"	6'8"	8'0"	6'8"
					
2'8" • 2'10" • 3'0"	2'8" • 2'10" • 3'0"	2'8" • 2'10" • 3'0"	3'0"	3'0" • 3'6"	2'8" • 3'0"
DRS6170 	DRS6180 	DRS63	DRS80 	DRS8080 	DRS90
SHAKER PROFILE DOORS					
6'8"	6'8"	6'8"	8'0"	6'8"	
					
2'8" • 2'10" • 3'0"	2'8" • 2'10" • 3'0"	2'8" • 2'10" • 3'0"	3'0" • 3'6"	2'8" • 2'10" • 3'0"	
DRS1K 	DRS2K 	DRS3F 	DRS3F80 	DRS50  	

 COMING SOON - PLEASE CALL REGARDING AVAILABILITY

 IN STOCK  EXTENDED LEAD TIME  20/60 MIN FIRE RATED  TRIMMABLE (3'0" ONLY)  10" BOTTOM RAIL  HVHZ IMPACT NOT AVAILABLE IN 3'6"

Smooth Door • DRS3C B0P6



SMOOTH FLUSH PANEL DOOR



GLASS OPTIONS

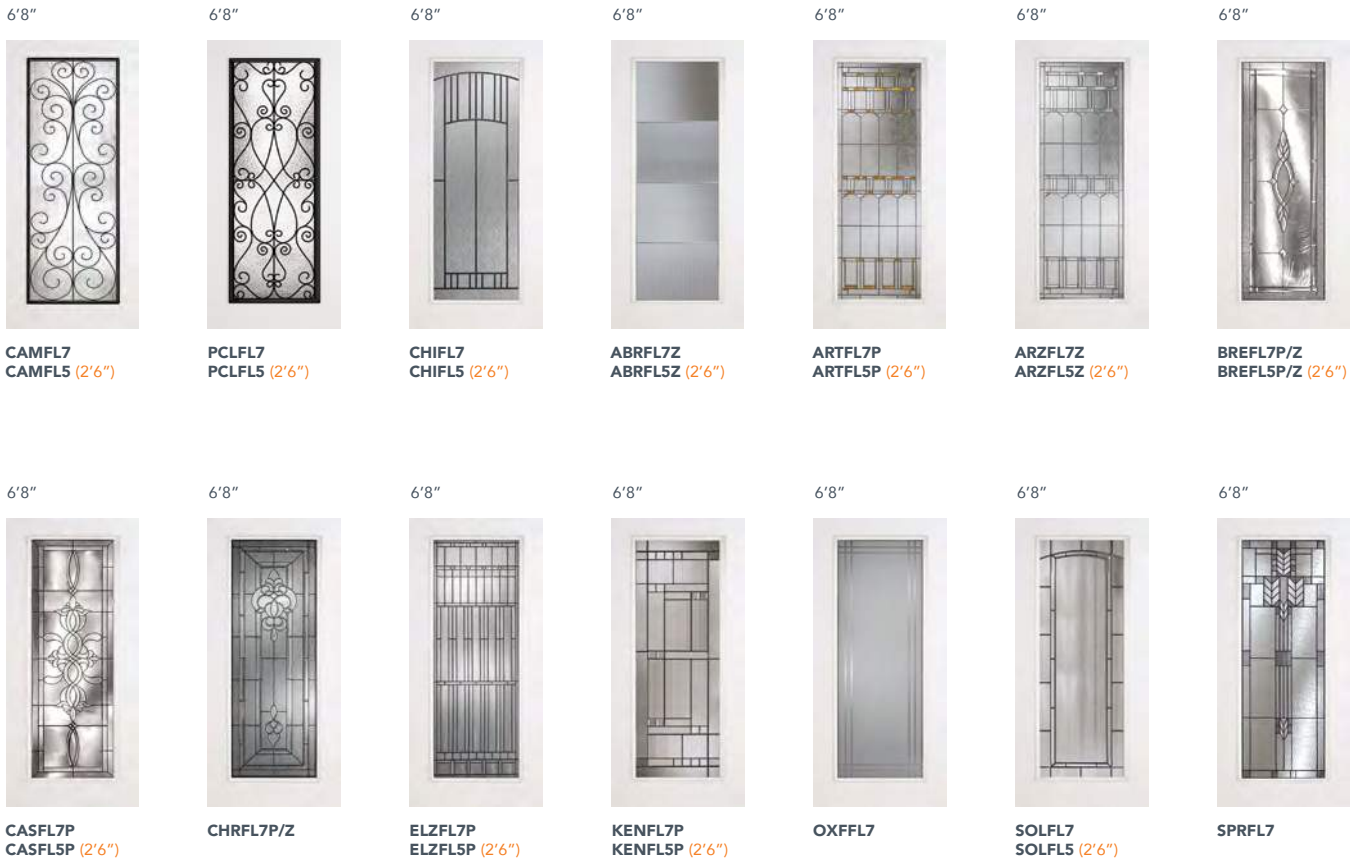

● IN STOCK ● EXTENDED LEAD TIME

SMOOTH FLUSH PANEL DOOR

6'8"



TABFL7P
TABFL5P (2'6")

6'8"



MBC/MBLFL7
MBC/MBLFL5 (2'6")

7'0"



CAMFL7
CAMFL5 (2'6")

7'0"



PCLFL7
PCLFL5 (2'6")

7'0"



CHIFL7
CHIFL5 (2'6")

7'0"



ABRFL7Z
ABRFL5Z (2'6")

7'0"



ARTFL7P
ARTFL5P (2'6")

7'0"



ARZFL7Z
ARZFL5Z (2'6")

7'0"



BREFL7P/Z
BREFL5P/Z (2'6")

7'0"



CASFL7P
CASFL5P (2'6")

7'0"



CHRFL7P/Z

7'0"



ELZFL7P
ELZFL5P (2'6")

7'0"



KENFL7P
KENFL5P (2'6")

7'0"



OXFFL7

7'0"



SOLFL7
SOLFL5 (2'6")

7'0"



SPRFL7

7'0"



TABFL7P
TABFL5P (2'6")

7'0"



MBC/MBLFL7
MBC/MBLFL5 (2'6")

8'0"



CAMFL8
CAMFL6 (2'6")

8'0"



PCLFL8
PCLFL6 (2'6")

8'0"



CHIFL8
CHIFL6 (2'6")

8'0"



ABRFL8Z
ABRFL6Z (2'6")

8'0"



ARTFL8P

8'0"



ARZFL8Z

8'0"



BREFL8P/Z

8'0"



CASFL8P

8'0"



ELZFL8P
ELZFL6P (2'6")

8'0"



KENFL8P

SMOOTH FLUSH PANEL DOOR

8'0"



OXFFL8

8'0"



SOLFL8P

8'0"



TABFL8P

8'0"



MBC/MBLFL8
MBC/MBLFL6 (2'6")

8'0"



CAMFL1 & FL2

8'0"



PCLFL1 & FL2

8'0"

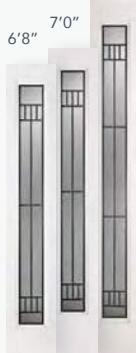

CHIFL1 & FL2

8'0"



ABRFL1Z & FL2Z

8'0"



ARTFL1P & FL2P

8'0"



ARZFL1Z & FL2Z

8'0"



BREFL1P/Z
& FL2P/Z

8'0"



CASFL1P & FL2P

8'0"

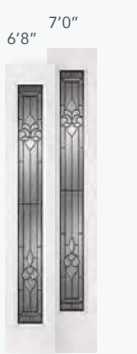

CHRFL1P/Z

8'0"

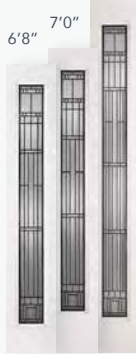

ELZFLP1 & FL2P

8'0"

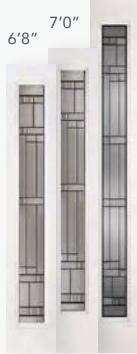

KENFLP1 & FL2P

8'0"



OXFFL1 & FL2

8'0"



SOLFL1P & FL2P

8'0"



SPRFL1P

8'0"

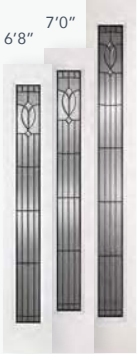

TABFL1P & FL2P

8'0"



MBC/MBLFL1 & FL2

SMOOTH TWO PANEL DOOR



GLASS OPTIONS



SMOOTH TWO PANEL DOOR

8'0"



PCL342

8'0"



CHI342

8'0"



ART342P

8'0"



ARZ342Z

8'0"



BRE342P/Z

8'0"



CAS342P

8'0"



CHR342P/Z

8'0"



ELZ342P

8'0"



KEN342P

8'0"



OXF342

8'0"



SOL342P

8'0"



SPR342P

8'0"



TAB342P

8'0"



CHIHL2 & FL1
CHIFL2

8'0"



ARTHL2P & FL1P
ART341P & FL2P

8'0"



ARZHL2Z & FL1Z
ARZ341Z & FL2Z

8'0"



BREHL2P/Z & FL1P/Z
ARZ341P/Z & FL2P/Z

8'0"



CASHL2P & FL1P
CAS341P & FL2P

8'0"



CHRHL2P/Z & FL1P/Z
CHR341P/Z

8'0"



ELZHL2P & FL1P
ELZ341P & FL2P

8'0"

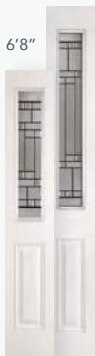

KENHL2P & FL1P
KEN341P & FL2P

8'0"



OXFHL2 & FL1
OXF341 & FL2

8'0"



SOLHL2P & FL1P
SOL341P & FL2P

8'0"



SPRHL2P & FL1P
SPR341P & FL2P

8'0"



TABFL1P
TAB341P & FL2P

8'0"



MBC/MBLHL2 & FL1
MBC/MBLFL2



Smooth Door • DRS4170

SMOOTH TWO PANEL DOOR

SQUARE PANEL & ARCH TOP



GLASS OPTIONS

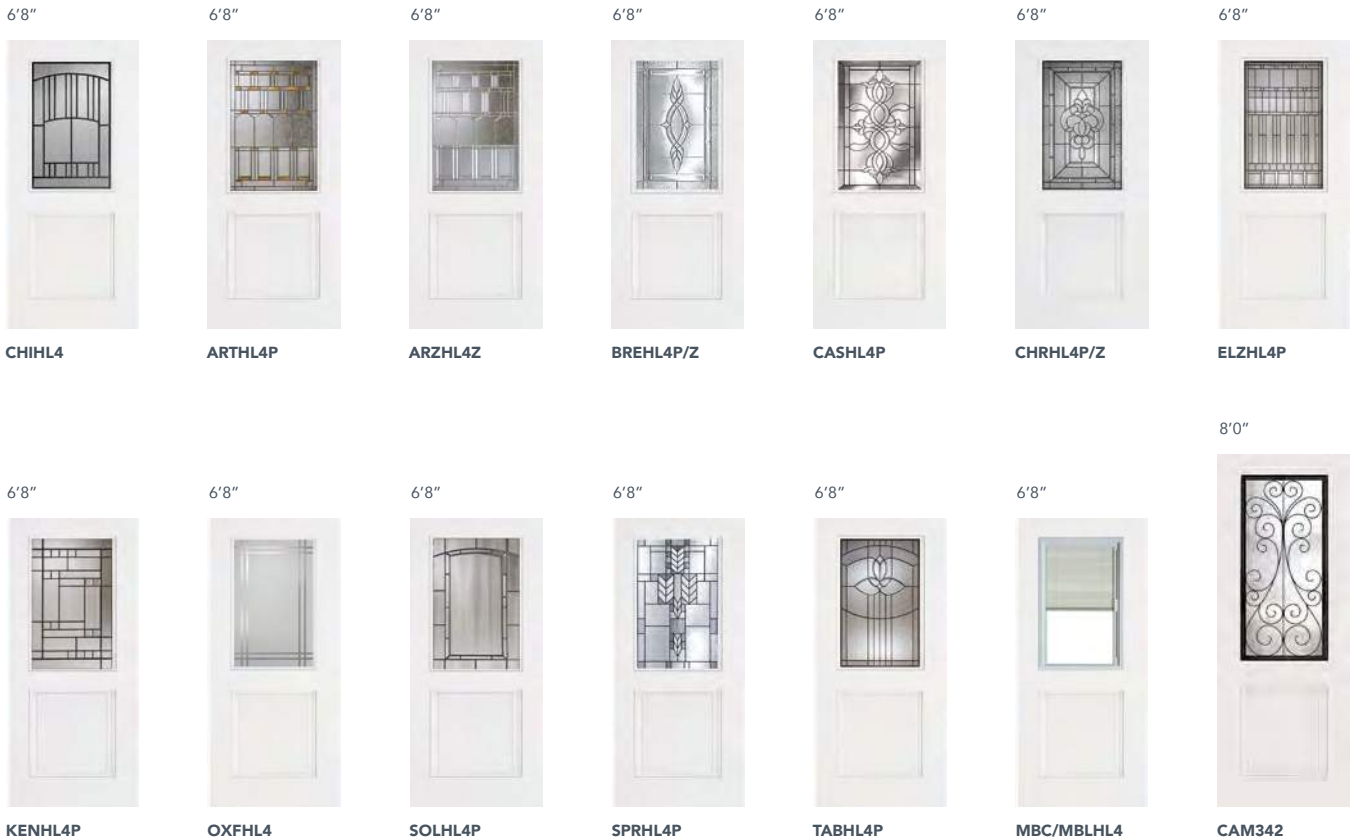

● IN STOCK ● EXTENDED LEAD TIME

8'0"



PCL342

8'0"



CHI342

8'0"



ART342P

8'0"



ARZ342Z

8'0"



BRE342P/Z

8'0"



CAS342P

8'0"



CHR342P/Z

8'0"



ELZ342P

8'0"



KEN342P

8'0"



OXF342

8'0"



SOL342P

8'0"



SPR342P

8'0"



TAB342P

8'0"



CHIH2 & FL1
CHIF2

8'0"



ARTH2P & FL1P
ART341P

8'0"

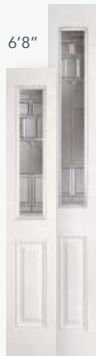

ARZHL2Z & FL1Z
ARZ341Z

8'0"



BREHL2P/Z & FL1P/Z
BRE341P/Z

8'0"



CASH2P & FL1P
CAS341P

8'0"



CHRHL2P/Z & FL1P/Z
CHR341P/Z

8'0"



ELZHL2P & FL1P
ELZ341P

8'0"

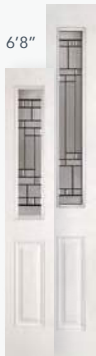

KENHL2P & FL1P
KEN341P

8'0"



OXFHL2 & FL1
OXF341

8'0"



SOLHL2P & FL1P
SOL341P

8'0"



SPRHL2P & FL1P
SPR341P

8'0"



TABFL1P
TAB341

8'0"



MBC/MBLHL2 & FL1
MBC341

SMOOTH COTTAGE TWO PANEL DOOR

SQUARE PANEL & ARCH TOP



GLASS OPTIONS

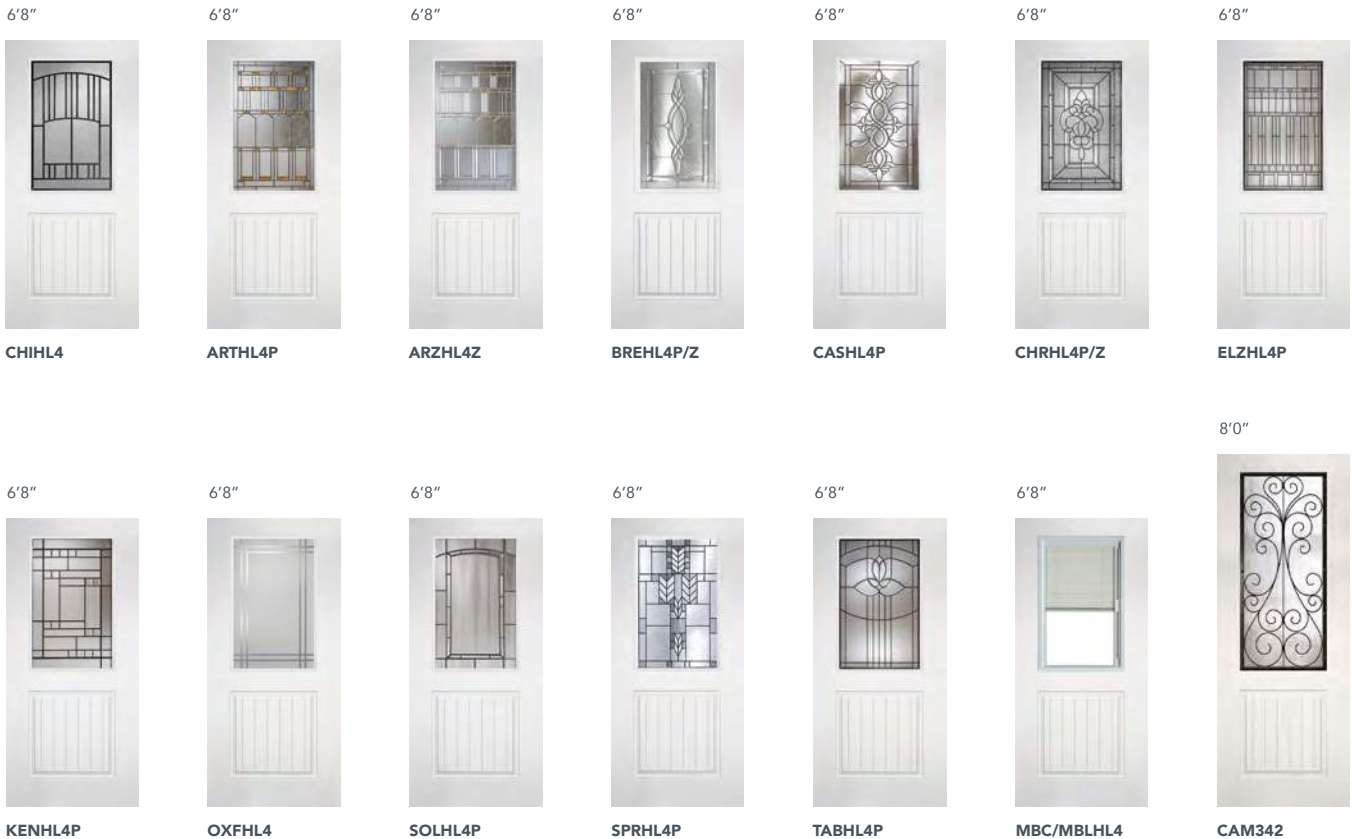

● IN STOCK ● EXTENDED LEAD TIME

SMOOTH COTTAGE TWO PANEL DOOR

8'0"



PCL342

8'0"

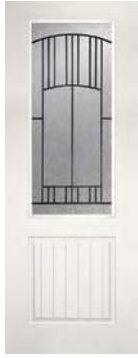

CHI342

8'0"



ART342P

8'0"



ARZ342Z

8'0"



BRE342P/Z

8'0"



CAS342P

8'0"



CHR342P/Z

8'0"



ELZ342P

8'0"



KEN342P

8'0"



OXF342

8'0"



SOL342P

8'0"



SPR342P

8'0"



TAB342P

8'0"



CHIHL2 & FL1
CHIFL2

8'0"



ARTHL2P & FL1P
ART341P

8'0"



ARZHL2Z & FL1Z
ARZ341Z

8'0"



BREHL2P/Z & FL1P/Z
BRE341P/Z

8'0"

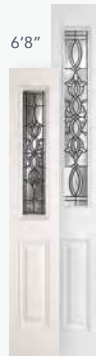

CASHL2P & FL1P
CAS341P

8'0"



CHRHL2P/Z & FL1P/Z
CHR341P/Z

8'0"



ELZHL2P & FL1P
ELZ341P

8'0"

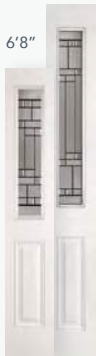

KENHL2P & FL1P
KEN341P

8'0"



OXFHL2 & FL1
OXF341

8'0"



SOLHL2P & FL1P
SOL341P

8'0"



SPRHL2P & FL1P
SPR341P

8'0"



TABFL1P
TAB341P

8'0"



MBC/MBLHL2 & FL1
MBC/MBLFL2

SMOOTH 3/4 HERITAGE DOOR

6'8"



3'0"

DR520

SLS3E

1'0" • 12"

GLASS OPTIONS

6'8"



BRE3V2P/Z

6'8"



CAS3V2P

6'8"



CHR3V2P/Z

6'8"



TAB3V2P

6'8"



CAS343P

6'8"



BRE341P/Z

6'8"



CAS341P

6'8"



CHR341P/Z

6'8"



TAB341P

SMOOTH 3/4 TWO PANEL DOOR



GLASS OPTIONS

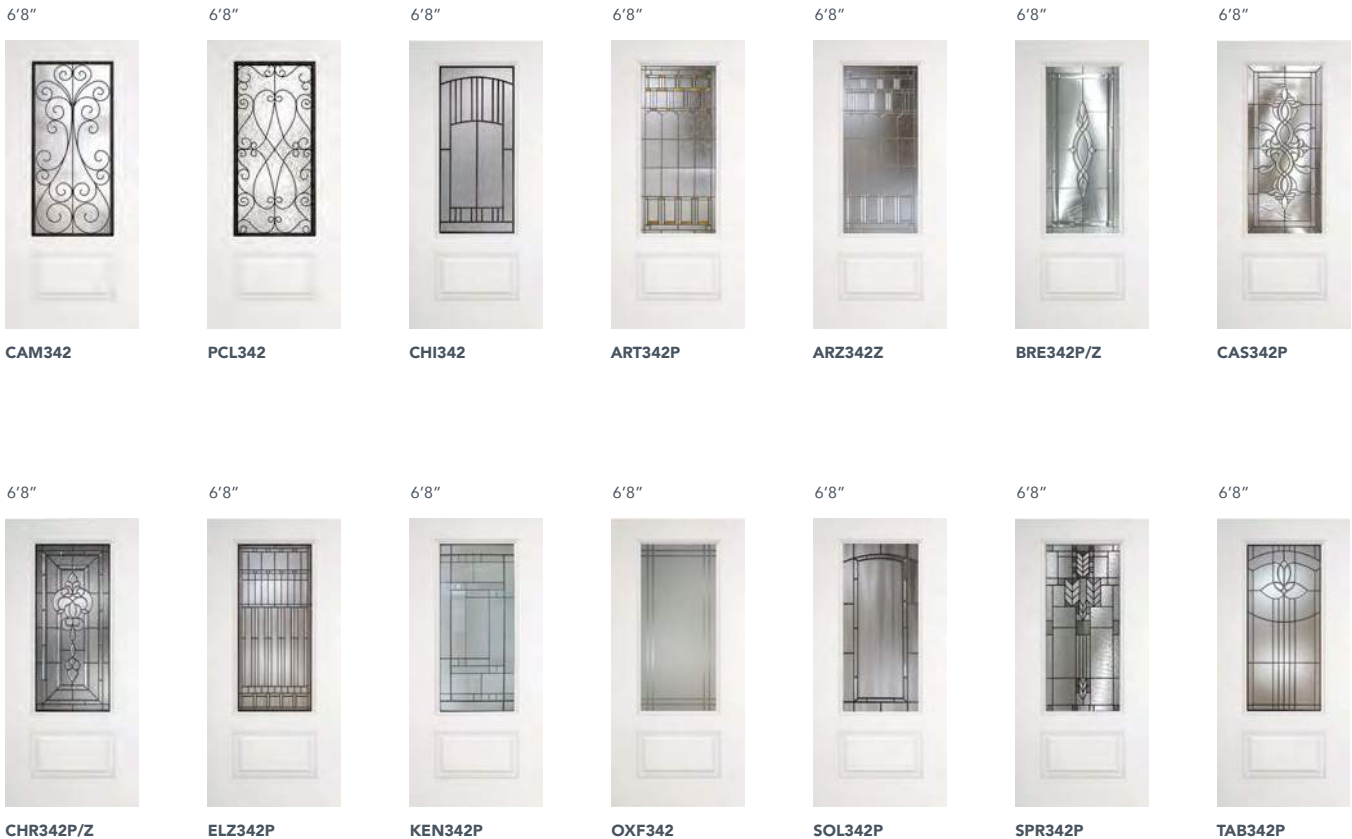

● IN STOCK ● EXTENDED LEAD TIME

3/4 TWO PANEL DOOR

8'0"



CAMFL7

8'0"



PCLFL7

8'0"

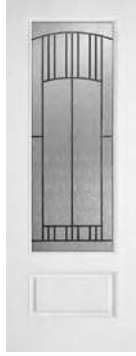

CHIFL7

8'0"



ABRFL7Z

8'0"



ARTFL7P

8'0"



ARZFL7Z

8'0"



BREFL7P/Z

8'0"



CASFL7P

8'0"



CHRFL7P/Z

8'0"



ELZFL7P

8'0"



KENFL7P

8'0"



OXFFL7

8'0"



SOLFL7P

8'0"

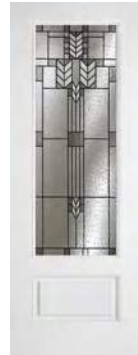

SPRFL7P

8'0"



TABFL7P

8'0"



MBC/MBFL7

8'0"

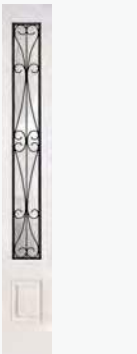

CAMFL1

8'0"

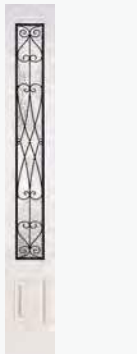

PCLFL1

8'0"



CHIFL1

8'0"



ABRFL1Z

8'0"



ART341P
ARTFL1P

8'0"



ARZ341Z
ARZFL1Z

8'0"



BRE341P/Z
BREFL1P/Z

3/4 TWO PANEL DOOR



CAS341P
CASFL1P

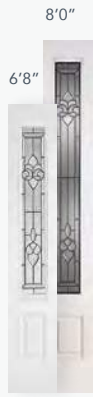

CHR341P/Z
CHRFL1P/Z



ELZ341P
ELZFL1P

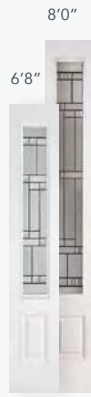

KEN341P
KENFL1P



OXF341
OXFFL1



SOL341P
SOLFL1P

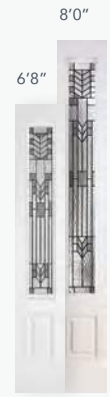

SPR341P
SPRFL1P

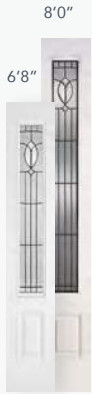

TAB341P
TABFL1P



MBC/MBLFL1



Smooth Door • DRS2980 • Glass SOLFL7P

SMOOTH DIRECT GLAZE CRAFTSMAN

DR53C & DR53C80 & MATCHING SIDELITES ARE ONLY AVAILABLE WITH GLASS



GLASS OPTIONS



● IN STOCK ● EXTENDED LEAD TIME ● EXTENDED LEAD TIME ON GLASS

SMOOTH 3/4 ELITE DOOR

6'8"



3'0"

DR53E

SL53E

10" • 12"

GLASS OPTIONS

6'8"



BRE3V2P/Z

6'8"



CAS3V2P

6'8"



CHR3V2P/Z

6'8"



TAB3V2P

6'8"



CAS343P

6'8"



BREFL1P/Z

6'8"



CAS341P

6'8"



CHR341P/Z

6'8"



TAB341P

● IN STOCK

● EXTENDED LEAD TIME



Smooth Door • DRS0080 • Glass ELZFL8P

SMOOTH 3/4 PREMIUM DOOR

6'8"



3'0"

DR53P

SLS3P

1'0" • 1'2"

GLASS OPTIONS

6'8"



BRE3V2P/Z

6'8"



CAS3V2P

6'8"



CHR3V2P/Z

6'8"



TAB3V2P

6'8"



BRE3V1P/Z

6'8"



CAS3V1P

6'8"



CHR3V1P/Z

6'8"



TABFL1P

SMOOTH 3/4 PANEL DOOR

8'0"



DR53080

SL53080

2'8" • 3'0" • 3'6"

1'0" • 1'2"

GLASS OPTIONS

8'0"



BRE3V3P/Z

8'0"



CAS3V3P

8'0"



CAMFL7

8'0"



PCLFL7

8'0"

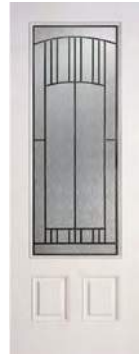

CHIFL7

8'0"



ABRFL7Z

8'0"



ARTFL7P

8'0"



ARZFL7Z

8'0"



BREFL7P/Z

8'0"



CASFL7P

8'0"



CHRFL7P/Z

8'0"



ELZFL7P

8'0"



KENFL7P

8'0"



OXFFL7

3/4 THREE PANEL DOOR

8'0"



SOLFL7P

8'0"



SPRFL7P

8'0"



TABFL7P

8'0"



MBC/MBLFL7

8'0"



CAMFL

8'0"



PCLFL1

8'0"



CHILFL1

8'0"



ABRFL1Z

8'0"



ARTFL1P

8'0"



ARZFL1Z

8'0"



BREFL1P/Z

8'0"



CASFL1P

8'0"



CHRFL1P/Z

8'0"



ELZFL1P

8'0"



KENFL1P

8'0"



OXFFL1

8'0"



SOLFL1P

8'0"



SPRFL1P

8'0"



TABFL1P

8'0"



MBC/MBLFL1

SMOOTH THREE PANEL DOOR

6'8"



DR531

7'0"



DR53170

SMOOTH FOUR PANEL BLANK TOP DOOR



GLASS OPTIONS



CASHR1P



CHRR1P/Z



TABHR1P



CHIHL4
CHIHL3 (2'6")



ARTHL4P
ARTHL3P (2'6")



ARZHL4Z
ARZHL3Z (2'6")



BREHL4P/Z



CASHL4P
CASHL3P (2'6")



CHRH4P/Z



ELZHL4P
ELZHL3P (2'6")

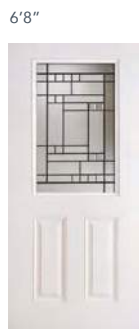

KENHL4P
KENHL3P (2'6")



OXFHL4



SOLHL4P
SOLHL3P (2'6")



SPRHL4P

● IN STOCK ● EXTENDED LEAD TIME

FOUR PANEL BLANK TOP DOOR

6'8"



TABHL4P
TABHL3P (2'6")

6'8"



MBC/MBLHL4

6'8"



CHIHL2

6'8"

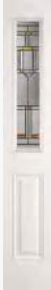

ARTHL2P

6'8"



ARZHL2Z

6'8"



BREHL2P/Z

6'8"



CASHL2P

6'8"



CHRHL2P/Z

6'8"



ELZHL2P

6'8"



KENHL2P

6'8"



OXFHL2

6'8"

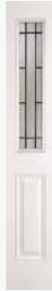

SOLHL2P

6'8"



SPRHL2P

6'8"



TABFL1P

6'8"

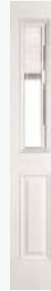

MBC/MBLHL2

SMOOTH TRUE FOUR PANEL DOOR



GLASS OPTIONS



● IN STOCK ● EXTENDED LEAD TIME

TRUE FOUR PANEL DOOR

7'0"



CHIHL4

7'0"



ARTHL4P

7'0"



ARZHL4Z

7'0"



BREHL4P/Z

7'0"



CASHL4P

7'0"



CHRHL4P

7'0"



ELZHL4P

7'0"



KENHL4P

7'0"



OXFHL4

7'0"



SOLHL4P

7'0"



SPRHL4P

7'0"



TABHL4P

7'0"



MBC/MBLHL4

8'0"



CAM342

8'0"



PCL342

8'0"

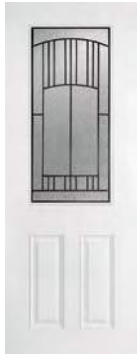

CHI342

8'0"



ART342P

8'0"



ARZ342Z

8'0"



BRE342P/Z

8'0"



CAS342P

8'0"



CHR342P/Z

8'0"



ELZ342P

8'0"



KEN342P

8'0"



OXF342

8'0"



SOL342P

8'0"

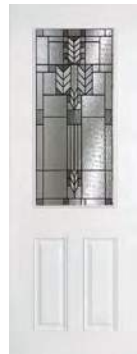

SPR342P

8'0"



TAB342P

TRUE FOUR PANEL DOOR



SMOOTH 3/4 FOUR PANEL DOOR

6'8"



2'8" • 2'10" • 3'0"

1'0" • 1'2"

DR549

SLS49

GLASS OPTIONS

6'8"



CAM342

6'8"



PCL342

6'8"



CHI342

6'8"



ART342P

6'8"



ARZ342Z

6'8"



BRE342P/Z

6'8"



CAS342P

6'8"



CHR342P/Z

6'8"



ELZ342P

6'8"



KEN342P

6'8"



OXF342

6'8"



SOL342P

6'8"



SPR342P

6'8"



TAB342P

3/4 FOUR PANEL DOOR

6'8"



ART341P

6'8"



ARZ341Z

6'8"



BRE341P/Z

6'8"



CAS341P

6'8"



CHR341P/Z

6'8"



ELZ341P

6'8"



KEN341P

6'8"



OXF341

6'8"



SPR341P

6'8"



SOL341P

6'8"



TAB341P

SMOOTH SIX PANEL CRAFTSMAN DOOR

6'8"



3'0"

DR56C



SMOOTH ACCESSORIES AVAILABLE ON PAGE 153.

6'8"



ARTTL3P

6'8"



ARZTL3Z

6'8"



BRETL3P/Z

6'8"



ELZTL3P

6'8"



OXFTL3

6'8"



SOLTL3P

6'8"



SPRTL3P

SMOOTH SIX PANEL DOOR



GLASS OPTIONS

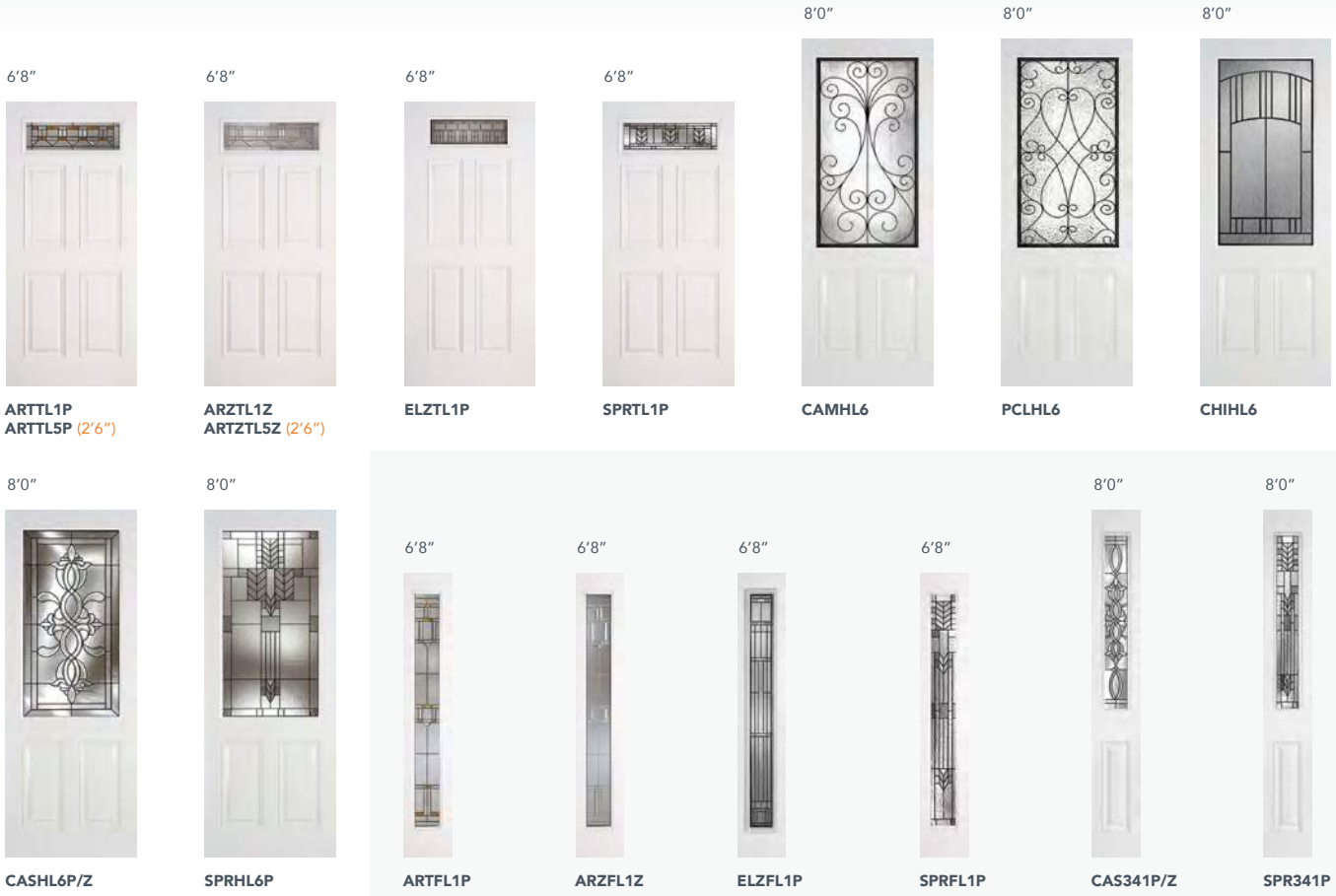

● IN STOCK ● EXTENDED LEAD TIME



SMOOTH SIX PANEL UTILITY DOOR



DRS61
DRS6B (No matching sidelite)

SLS61

DRS6170

SLS6170

DRS6180

GLASS OPTIONS

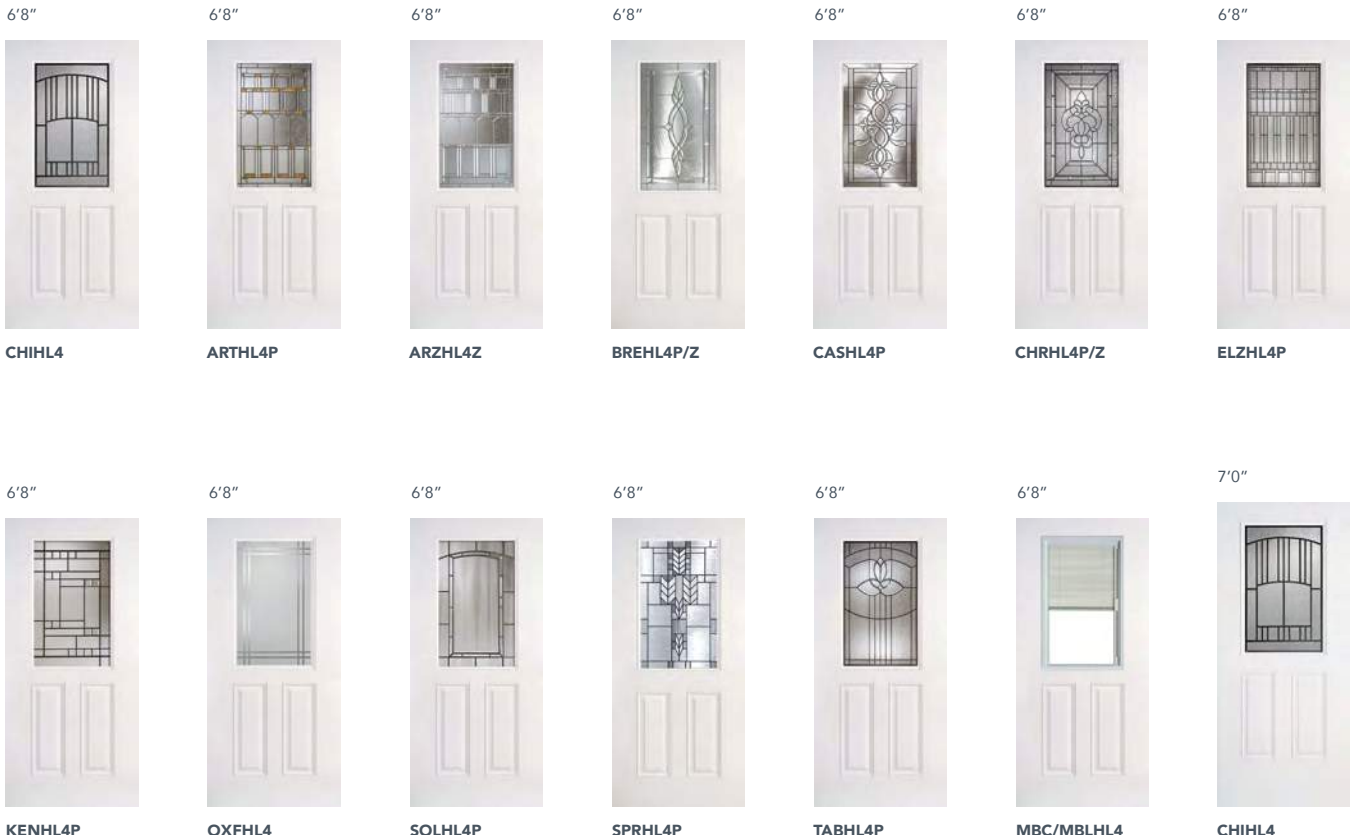

CHIHL4

ARTHL4P

ARZHL4Z

BREHL4P/Z

CASHL4P

CHRHL4P/Z

ELZHL4P

KENHL4P

OXFHL4

SOLHL4P

SPRHL4P

TABHL4P

MBC/MBLHL4

CHIHL4

● IN STOCK ● EXTENDED LEAD TIME

SIX PANEL UTILITY DOOR

7'0"



ARTHL4P

7'0"



ARZHL4Z

7'0"



BREHL4P/Z

7'0"



CASHL4P

7'0"



CHRHL4P/Z

7'0"



ELZHL4P

7'0"



KENHL4P

7'0"



OXFHL4

7'0"



SOLHL4P

7'0"



SPRHL4P

7'0"



TABHL4P

7'0"



MBC/MBLHL4

8'0"

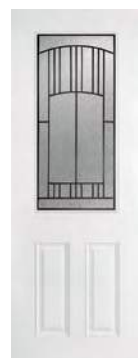

CHI342

8'0"



ART342P

8'0"



ARZ342Z

8'0"



BRE342P/Z

8'0"



CAS342P

8'0"

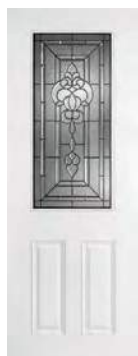

CHR342P/Z

8'0"



ELZ342P

8'0"



KEN342P

8'0"



OXF342

8'0"



SOL342P

8'0"



SPR342P

8'0"



TAB342P

SIX PANEL UTILITY DOOR



CHIHL2



ARTHL2P



ARZHL2Z



BREHL2P/Z



CASHL2P



CHRHL2P/Z



ELZHL2P



KENHL2P



OXFHL2



SOLHL2P



SPRHL2P



TABFL1P



MBC/MBLHL2

SMOOTH TRUE SIX PANEL NARROW DOOR



GLASS OPTIONS



● IN STOCK ● EXTENDED LEAD TIME

TRUE SIX PANEL NARROW DOOR

6'8"



CHIHL2P

6'8"

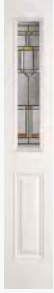

ARTHL2P

6'8"



ARZHL2Z

6'8"



BREHL2ZP/Z

6'8"



CASHL2ZP

6'8"



CHRL2ZP/Z

6'8"



ELZHL2P

6'8"



KENHL2P

6'8"



OXFHL2

6'8"



SOLHL2P

6'8"

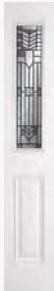

SPRHL2P

6'8"



TABFL1

6'8"



MBC/MBLHL2

Smooth Door • DRS63 • Glass KENHL4P



SMOOTH EIGHT PANEL DOOR



GLASS OPTIONS



● IN STOCK ● EXTENDED LEAD TIME

SMOOTH NINE PANEL DOOR

6'8"



2'8" • 3'0"

DRS90

6'8"



BRE9P1P/Z

6'8"



SPR9P1P

● IN STOCK

● EXTENDED LEAD TIME



Smooth Door • DRS2G80 • Glass SPR342P

SMOOTH ONE PANEL SHAKER DOOR



SHAKER PROFILE

The straightforward shaker design showcases the beauty that minimal design can offer. Our shaker focuses on simplicity and is easily adaptable for any home's exterior.

SMOOTH TWO PANEL SHAKER DOOR



SMOOTH THREE PANEL CRAFTSMAN

SHAKER PROFILE



SMOOTH FIVE PANEL DOOR

SHAKER PROFILE





Smooth Door • DR550



SMOOTH ACCESSORIES

3 Lite



6'8" ACSDW/23005
8'0" ACSDW/23001

SIMULATED DIVIDED LIGHTS "SDL" BARS

Plastpro Simulated Divided Lights (SDL Bars) can be used on the interior and exterior of our doors and help create personalized, unique looks. They are easy to install and will not rot or absorb moisture.

6 Lite



6'8" ACSDW/23006
8'0" ACSDW/23002

Sidelite



ACSDW/23004

FEATURES & BENEFITS

- Easy installation using common wood working tools and equipment.
- Will not rot or absorb moisture and resists the growth of fungus and mildew.
- Closed cellular structure prevents paint from peeling off the surface.
- Will not warp or crack when properly installed, or be affected by UV rays when properly coated.



Smooth Door • DRS6C • Glass SPRTL3 • Dentil Shelf ACDSSW2716

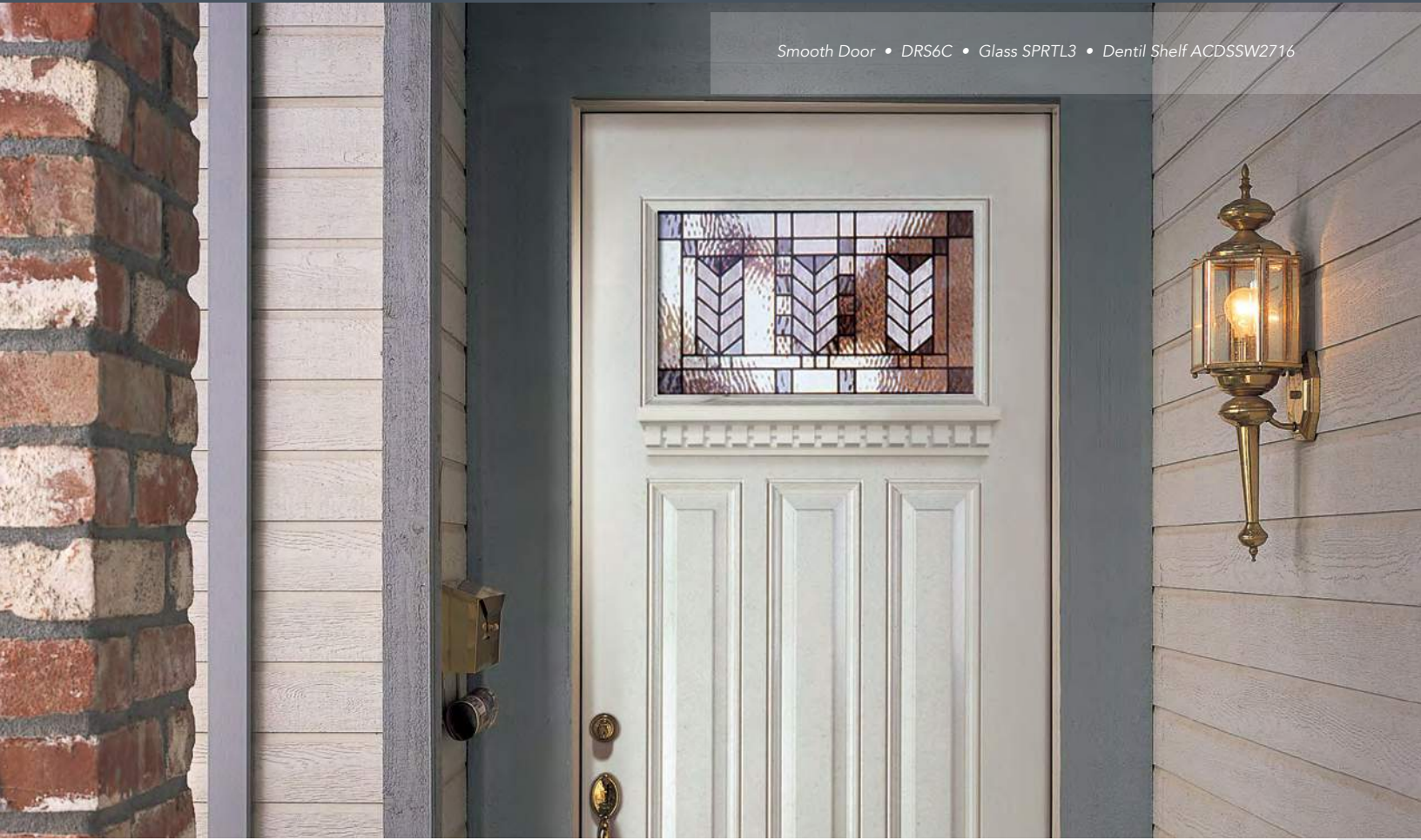

4 Block Dentil Shelf (DRS3F)



ACDSSW2404

4 Block Dentil Shelf



ACDSSW2704

16 Block Dentil Shelf



ACDSSW2716

DENTIL SHELF

Plastpro Dentil Shelves are made of lightweight High Density Polyurethane (HDP) and will not warp, rot, or crack. HDP is an excellent alternative to traditional wood products.

FEATURES & BENEFITS

- Recreate Classic Design
- Create Custom Looks
- Affordable

TRUE WHITE OAK



True White Oak Door • DRW60

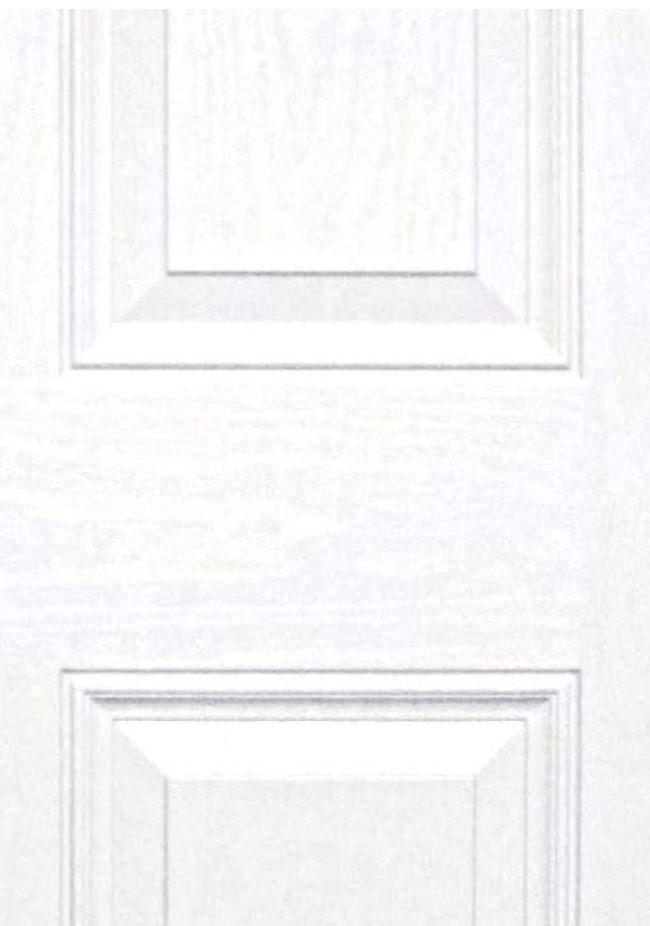

The True White Oak Series combines the best features of our Smooth and Oak Doors. Any home can enjoy a rich oak texture pattern in a pre-pigmented white skin. With many choices of decorative glass to choose from, create a look that is both timeless and modern.

DOOR OVERVIEW

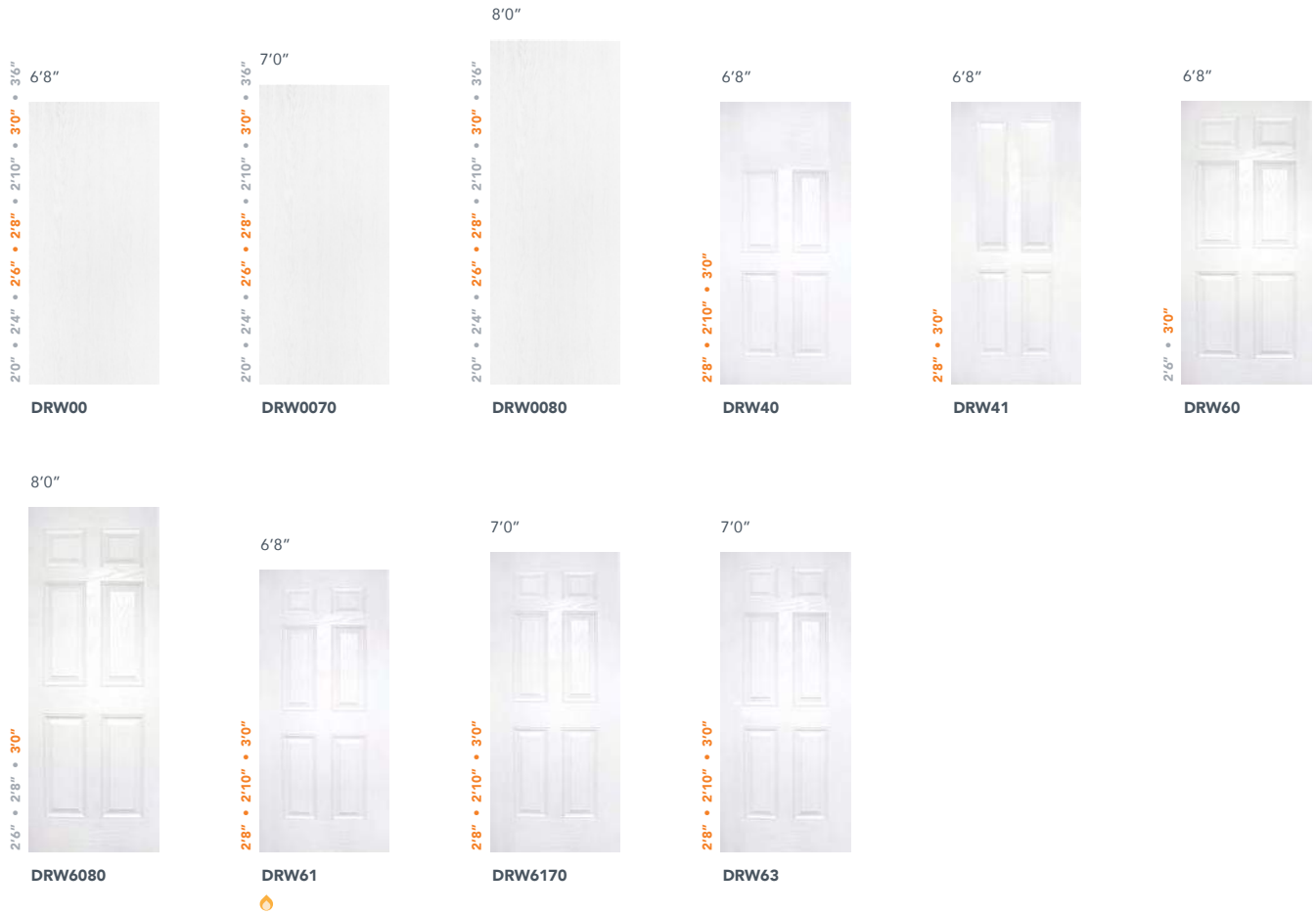

TRUE WHITE OAK FLUSH PANEL DOOR



GLASS OPTIONS

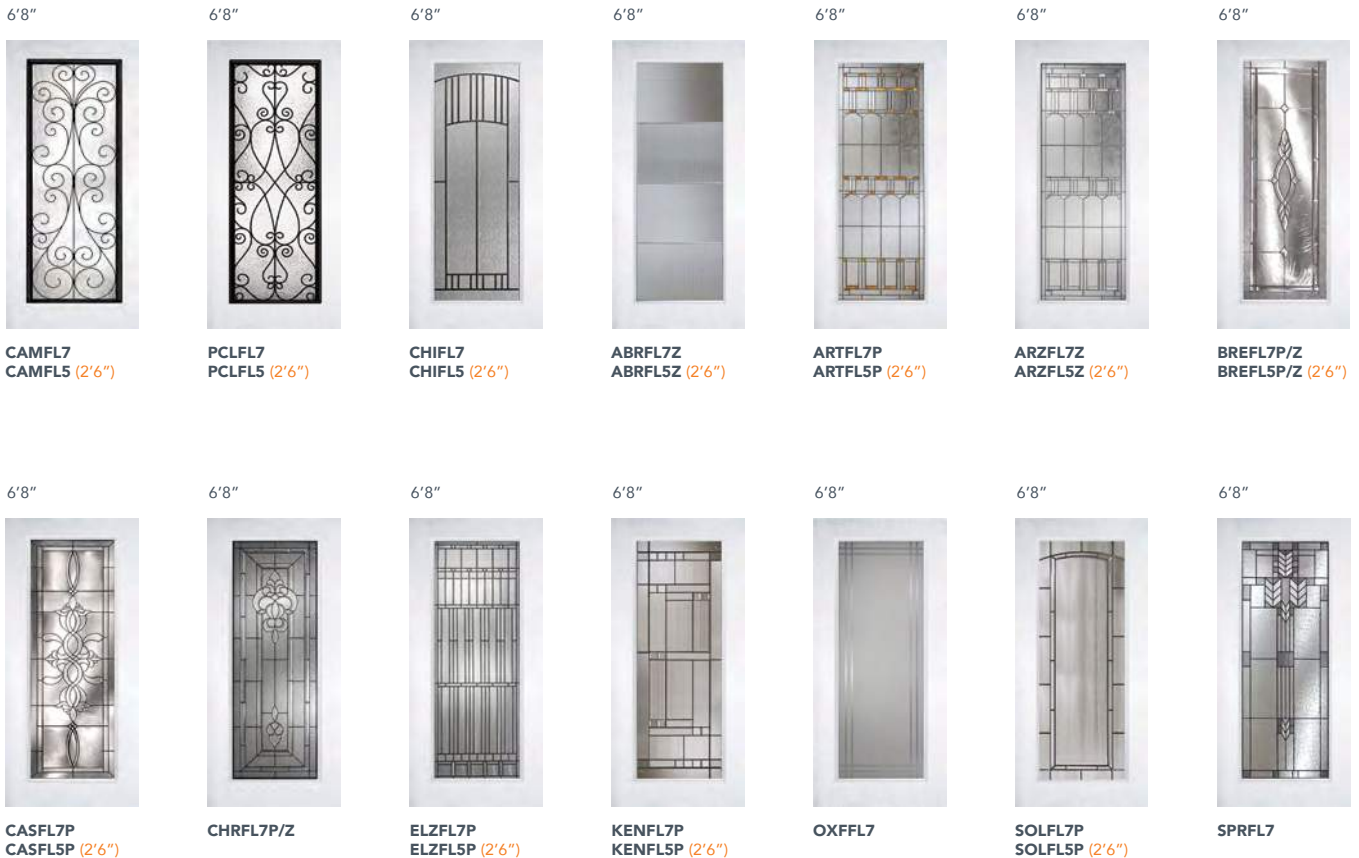

● IN STOCK ● EXTENDED LEAD TIME

TRUE WHITE OAK FLUSH PANEL DOOR

6'8"



TABFL7P
TABFL5P (2'6")

6'8"



MBC/MBLFL7
MBC/MBLFL5 (2'6")

7'0"



CAMFL7
CAMFL5 (2'6")

7'0"



PCLFL7
PCLFL5 (2'6")

7'0"



CHIFL7
CHIFL5 (2'6")

7'0"



ABRFL7Z
ABRFL5Z (2'6")

7'0"



ARTFL7P
ARTFL5P (2'6")

7'0"



ARZFL7Z
ARZFL5Z (2'6")

7'0"



BREFL7P/Z
BREFL5P/Z (2'6")

7'0"



CASFL7P
CASFL5P (2'6")

7'0"



CHRFL7P/Z

7'0"



ELZFL7P
ELZFL5P (2'6")

7'0"



KENFL7P
KENFL5P (2'6")

7'0"



OXFFL7

7'0"



SOLFL7P
SOLFL5P (2'6")

7'0"



SPRFL7P

7'0"



TABFL7P
TABFL5P (2'6")

7'0"



MBC/MBLFL7
MBC/MBLFL5 (2'6")



CAMFL8
CAMFL6 (2'6")

8'0"



PCLFL8
PCLFL6 (2'6")

8'0"



CHIFL8
CHIFL6 (2'6")

8'0"



ABRFL8Z
ABRFL6Z (2'6")

8'0"



ARTFL8P

8'0"



ARZFL8Z

8'0"



BREFL8P/Z

8'0"



CASFL8P

8'0"



ELZFL8P
ELZFL6P (2'6")

8'0"



KENFL8P

TRUE WHITE OAK FLUSH PANEL DOOR

8'0"



OXFFL8

8'0"



SOLFL8P

8'0"



TABFL8P

8'0"



MBC/MBFL8
MBC/MBFL6 (2'6")

8'0"



CAMFL1 & FL2

8'0"



PCLFL1 & FL2

8'0"



CHIFL1 & FL2

8'0"



ABRFL1Z & FL2Z

8'0"



ARTFL1P & FL2P

8'0"



ARZFL1Z & FL2Z

8'0"



BREFL1P/Z
& FL2P/Z

8'0"

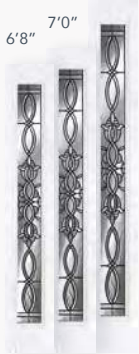

CASFL1 & FL2

8'0"

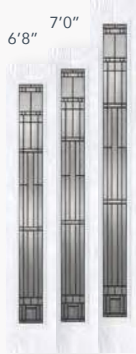

ELZFLP1 & FL2P

8'0"

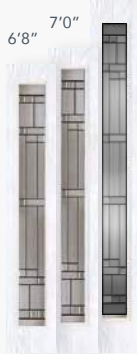

KENFLP1 & FL2P

8'0"



OXFFL1 & FL2

8'0"



SOLFL1P & FL2P

8'0"

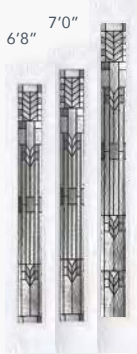

SPRFL1P & FL2P

8'0"

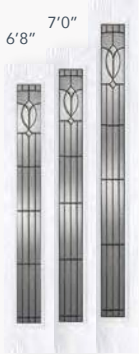

TABFL1P & FL2P

8'0"



MBC/MBFL1 & FL2

TRUE WHITE OAK FOUR PANEL BLANK TOP DOOR



GLASS OPTIONS



CASHR1P



CHRR1P/Z



TABHR1P



CHIHL4



ARTHL4P



ARZHL4Z



BREHL4P/Z



CASHL4P



CHRH4P/Z



ELZHL4P



KENHL4P



OXFHL4



SOLHL4P



SPRHL4P

● IN STOCK

● EXTENDED LEAD TIME

FOUR PANEL BLANK TOP DOOR

6'8"



TABHL4P

6'8"



MBC/MBLHL4

6'8"



CHHL2

6'8"



ARTHL2P

6'8"



ARZHL2Z

6'8"



BREHL2P/Z

6'8"



CASHL2P

6'8"



CHRHL2P/Z

6'8"



ELZHL2P

6'8"



KENHL2P

6'8"



OXFHL2

6'8"



SOLHL2P

6'8"



SPRHL2P

6'8"



TABFL1P

6'8"



MBC/MBLHL2



True White Oak Door • DRW00 • Glass TABFL7P

TRUE WHITE OAK TRUE FOUR PANEL DOOR

6'8"



2'8" • 3'0"

1'0" • 1'2"

DRW41

SLW60

GLASS OPTIONS

6'8"



CHIHL4

6'8"



ARTHL4P

6'8"



ARZHL4Z

6'8"



BREHL4P/Z

6'8"



CASHL4P

6'8"



CHRHL4P/Z

6'8"



ELZHL4P

6'8"



KENHL4P

6'8"



OXFHL4

6'8"



SOLHL4P

6'8"



SPRHL4P

6'8"



TABHL4P

6'8"



MBC/MBLHL4

TRUE FOUR PANEL DOOR

6'8"



CHHL2

6'8"



ARHL2P

6'8"



ARZHL2Z

6'8"



BREHL2P/Z

6'8"



CASHL2P

6'8"



CHRHL2P/Z

6'8"



ELZHL2P

6'8"



KENHL2P

6'8"



OXFHL2

6'8"



SOLHL2P

6'8"



SPRHL2P

6'8"



TABFL1P

6'8"



MBC/MCLHL2

TRUE WHITE OAK SIX PANEL DOOR



GLASS OPTIONS



TRUE WHITE OAK SIX PANEL UTILITY DOOR



GLASS OPTIONS

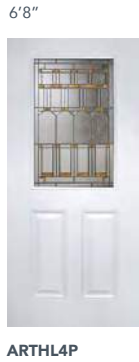

● IN STOCK

● EXTENDED LEAD TIME

SIX PANEL UTILITY DOOR

7'0"

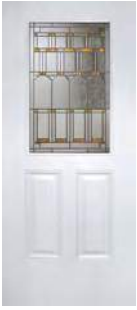

ARTHL4P

7'0"



ARZHL4Z

7'0"



BREHL4P/Z

7'0"



CASHL4P

7'0"



CHRHL4P/Z

7'0"



ELZHL4P

7'0"



KENHL4P

7'0"



OXFHL4

7'0"



SOLHL4P

7'0"



SPRHL4P

7'0"

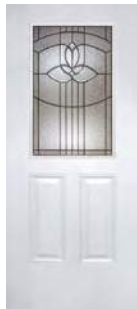

TABHL4P

7'0"



MBC/MBLHL4

6'8" 7'0"



CHIHL2

6'8" 7'0"



ARTHL2P

6'8" 7'0"



ARZHL2Z

6'8" 7'0"



BREHL2P/Z

6'8" 7'0"



CASHL2P

6'8" 7'0"



CHRHL2P/Z

6'8" 7'0"



ELZHL2P

6'8" 7'0"



KENHL2P

6'8" 7'0"



OXFHL2

6'8" 7'0"



SOLHL2P

6'8" 7'0"



SPRHL2P

6'8" 7'0"

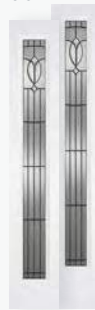

TABFL1P

6'8" 7'0"



MBC/MBLHL2



True White Oak Door • DRW00 • Glass ABRFLZZ

TRUE WHITE OAK

TRUE SIX PANEL NARROW DOOR

6'8"

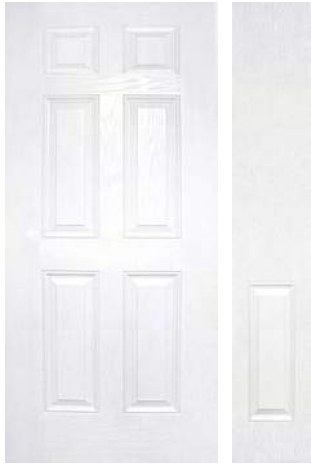

DRW63

SLW60

GLASS OPTIONS

6'8"



CHIHL4

6'8"



ARTHL4P

6'8"



ARZHL4Z

6'8"



BREHL4P/Z

6'8"



CASHL4P

6'8"



CHRHL4P/Z

6'8"



ELZHL4P

6'8"



KENHL4P

6'8"



OXFHL4

6'8"



SOLHL4P

6'8"



SPRHL4P

6'8"



TABHL4P

6'8"



MBC/MBLHL4

TRUE SIX PANEL NARROW DOOR

6'8"



CHIHL2P

6'8"



ARTHL2P

6'8"



ARZHL2Z

6'8"



BREHL2ZP/Z

6'8"



CASHL2P

6'8"



CHRL2ZP/Z

6'8"



ELZHL2P

6'8"



KENHL2P

6'8"



OXFHL2

6'8"



SOLHL2P

6'8"



SPRHL2P

6'8"



TABFL1

6'8"



MBC/MBLHL2



True White Oak Door • DRW00 • Glass ELZFL7P



ONELITE

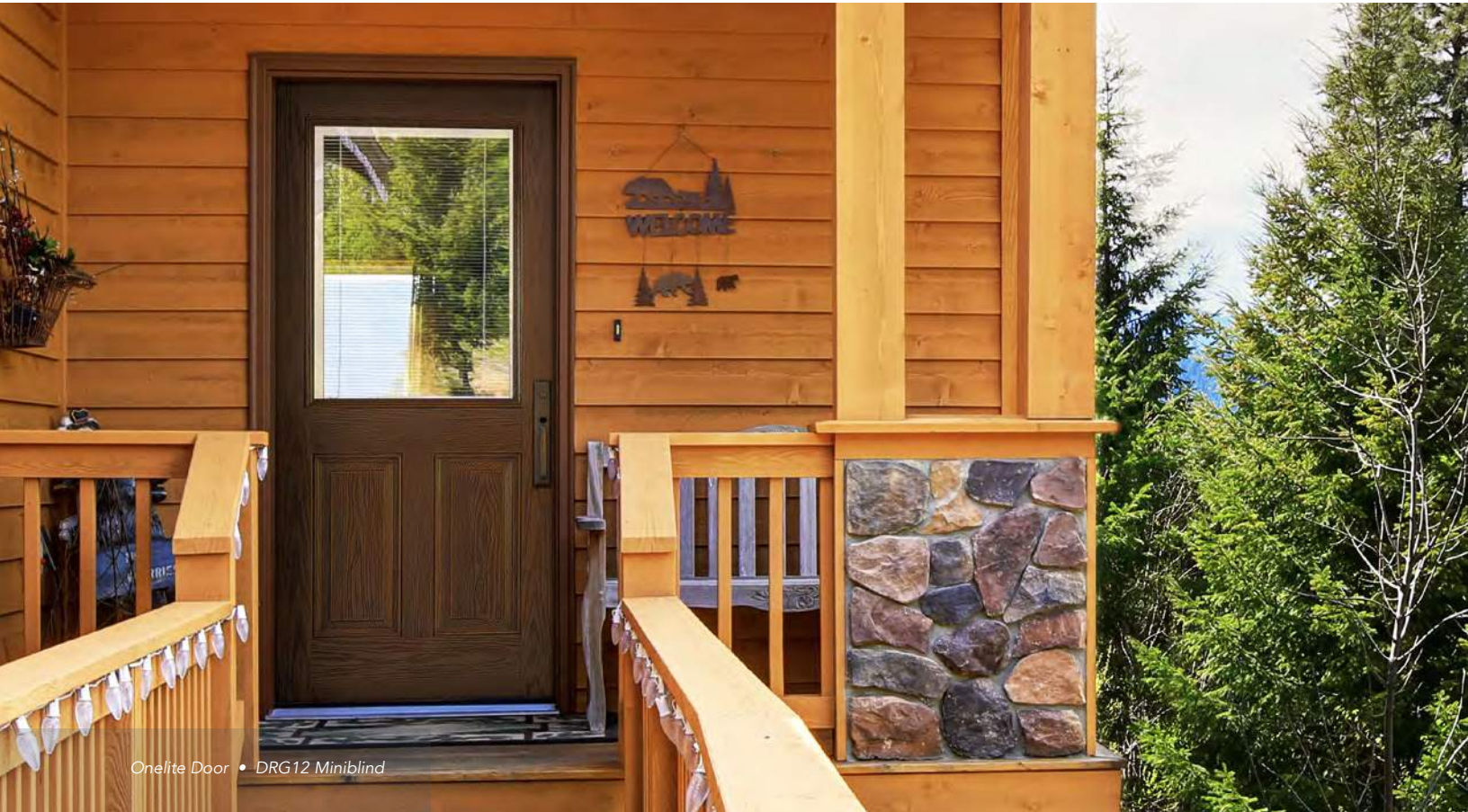

Onelite Door • DRG12 Miniblind

OAK GRAIN



SMOOTH FINISH

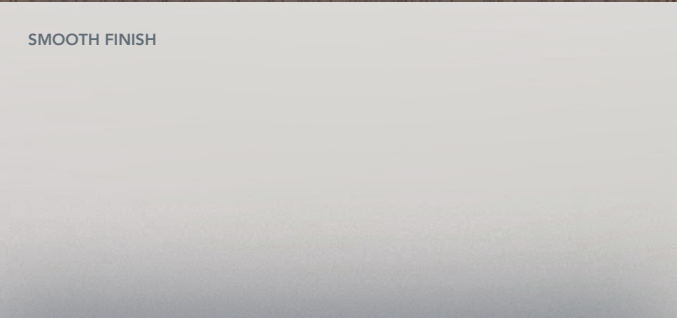

MAHOGANY GRAIN



Our Onelite Series features a fine, flush glazed glass with a removable stop to allow the glass to be switched without changing the entire door. Doors are available in Double-Insulated Tempered Glass, LowE, Grid Between Glass (GBG), or MiniBlinds.

ALL ONELITE DOORS ARE SHOWN PRE-FINISHED



This model complies with ADA standards and can accommodate ADA required hardware for easy operation. Reinforced blocking and closures allow the following flexible hardware to be installed: panic bars, reinforced arm closures, and exit rim devices. These devices are easy to grasp with one hand and don't require tight grasping or twisting to operate.



SMOOTH ADA DOOR

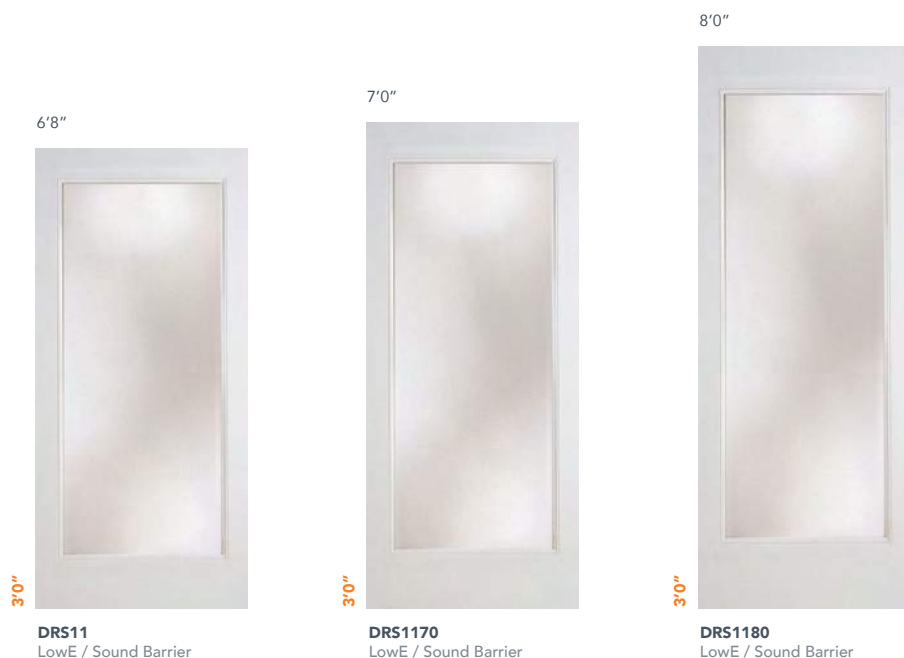

SPECIAL ORDER
Sound Barrier Glass (STC:34) 3'6"
and 4'0" widths

● IN STOCK

● EXTENDED LEAD TIME

FEATURES & BENEFITS



ONELITE FLUSH GLAZED HALF LITE DOOR



GLASS OPTIONS



ONELITE

FLUSH GLAZED HALF LITE DOOR

SMOOTH



GLASS OPTIONS



● IN STOCK ● EXTENDED LEAD TIME

ONELITE FLUSH GLAZE 3/4 LITE DOOR



GLASS OPTIONS

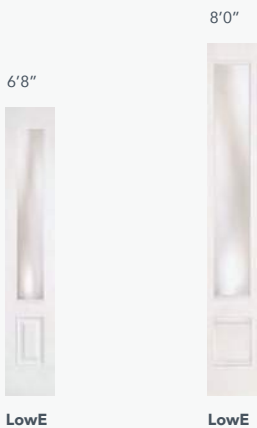

FLUSH GLAZED 3/4 LITE DOOR



GLASS OPTIONS



● IN STOCK ● EXTENDED LEAD TIME

ONELITE ACCESSORIES



AVAILABLE IN SMOOTH & MAHOGANY

8 & 10 Lite



6'8" ACSDM/S1368L08
8'0" ACSDM/S1380L10

9 Lite



6'8" ACSDM/S1368L09
8'0" ACSDM/S1380L09

SIMULATED DIVIDED LIGHTS "SDL" BARS

Plastpro Simulated Divided Lights (SDL Bars) can be used on the interior and exterior of our doors and help create personalized, unique looks. They are easy to install and will not rot or absorb moisture.

Sidelite



6'8" ACSDM/S1368L02
8'0" ACSDM/S1380L02

FEATURES & BENEFITS

- Easy installation using common wood working tools and equipment.
- Will not rot or absorb moisture, and resists the growth of fungus and mildew.
- Closed cellular structure prevents paint from peeling from the surface.
- Will not warp or crack when properly installed, or be affected by UV rays when properly coated.



DRM13C/L ACSDM1368 L08
SLM13C/L ACSDM1368 L02



DRM1380C/L ACSDM1380 L10
SLM1380C/L ACSDM1380 L02



DRM13C/L ACSDM1368 L09
SLM13C/L ACSDM1368 L02



DRM1380C/L ACSDM1380 L09
SLM1380C/L ACSDM1380 L02

ACCESSORIES ARE APPLIED BY PLASTPRO DISTRIBUTORS/DEALERS



NOVA SERIES



Nova Door • DRS1S w/ Miniblind



FIR GRAIN FINISH

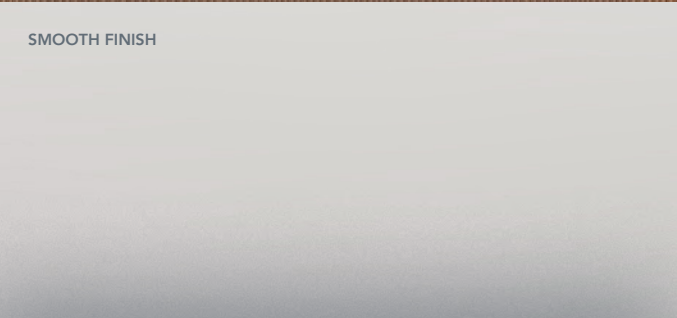

SMOOTH FINISH



BRUSHED SMOOTH FINISH

The Nova series features glass that is directly glazed into the door to create a seamless blend between the glass and door. The large pane glass allows for the greatest views and amount of light into your home; brightening up the space and filling it with energy. Nova comes in two sticking profiles: craftsman and square. The series is available in both Smooth and Fir grain.

ALL NOVA SERIES DOORS ARE SHOWN PRE-FINISHED

NOVA 45 SMOOTH FINISH & FIR GRAIN



NOVA 90 SMOOTH BRUSHED FINISH



NOVA 45 DIRECT GLAZED

SMOOTH & FIR GRAIN

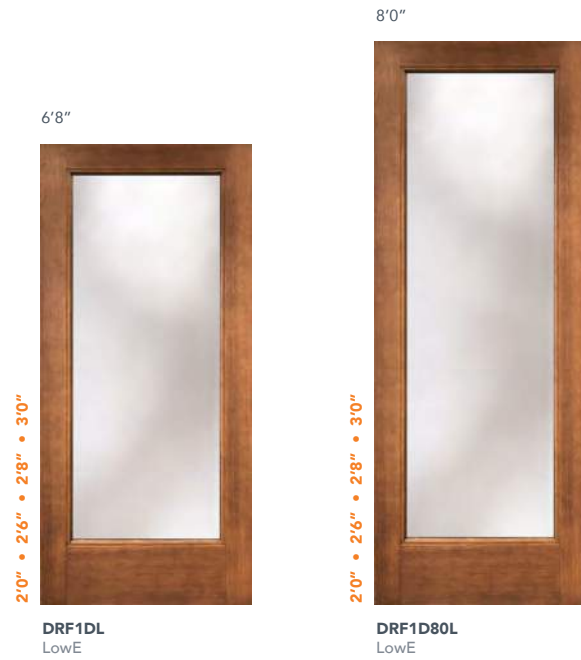

● IN STOCK ● EXTENDED LEAD TIME

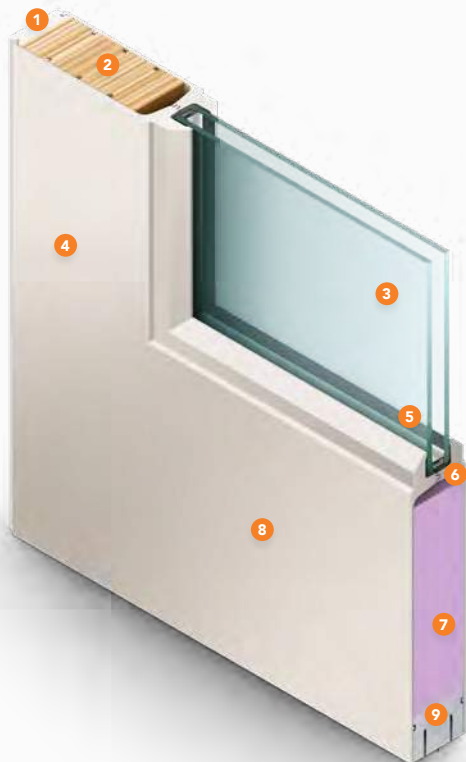

NOVA 45 FEATURES & BENEFITS

- 1 COMPOSITE STILE CAP
- 2 FULL LENGTH LVL (*Hinge & Strike side, for extra rigidity*)
- 3 INSULATED 3/4" GLASS (*LoE 272*)
- 4 COMPRESSION MOLDED FIBERGLASS SKIN
- 5 LEAK PROTECTION GLAZING TAPE
- 6 INTEGRALLY MOLDED GLASS STOP
- 7 HIGH INSULATION RIGID FOAM
- 8 ADA COMPLIANT BOTTOM RAIL
- 9 COMPOSITE BOTTOM RAIL

NOVA 90 DIRECT GLAZED



● IN STOCK ● EXTENDED LEAD TIME

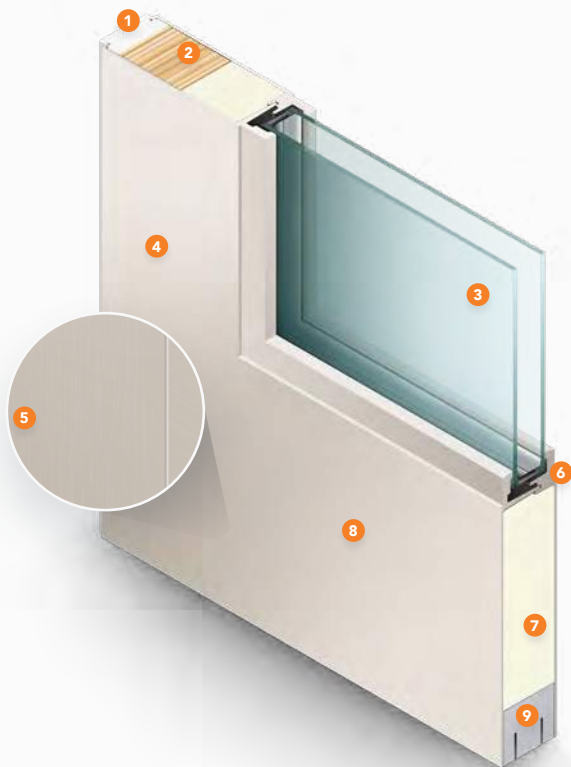

NOVA 90 FEATURES & BENEFITS

- 1 COMPOSITE STILE CAP
- 2 FULL LENGTH LVL (*Hinge & Strike side, for extra rigidity*)
- 3 INSULATED 1" GLASS (*Miniblind*)
- 4 COMPRESSION MOLDED FIBERGLASS SKIN
- 5 BRUSH FINISHED TEXTURE
- 6 INTEGRALLY MOLDED GLASS STOP
- 7 HIGH DENSITY POLYURETHANE FOAM
- 8 ADA COMPLIANT BOTTOM RAIL
- 9 COMPOSITE BOTTOM RAIL

PRE-FINISHED STAIN KIT & STAINING GUIDES

Plastpro Prefinished Stain Kit is an easy way to stain your fiberglass door exactly how you want for you home.

We've created easy step-by step directions using our stain kit to make staining your door a breeze. These staining instructions were created for staining our oak, rustic, fir, cherry, and mahogany skin series.

Our kit is designed exclusively for Plastpro fiberglass entry doors.



PRE-FINISHED KIT

Plastpro Pre-finished Stain Kit contains everything you need to stain one prehung door and two sidelites, or one double door unit.

BENEFITS & ADVANTAGES

- Protects the door from the sun, UV rays, and harsh winter weather.
- Faster drying time with environmentally friendly water based top coat. Easy to apply
- Special formula with long lasting vibrant colors.

BOX CONTAINS

- Zar® Exterior Water-Based Polyurethane (qt)
- Zar® Wood Stain (pt)
- Mineral Spirits (4 oz.)
- Two 2" Foam Brushes
- One 2.5" Synthetic Bristle Brush
- Cheese Cloths
- Two Stir Sticks
- One Pair of Latex Gloves
- Door Staining Instructions
- Two Skin Samples

LIMITED
5-YEAR
FINISH
WARRANTY

STAIN COLOR OPTIONS

The kit comes in seven different stain variations. Depending on your desired shade, you may need to apply the stain more than once for a darker finish. *Actual stain color may vary. To achieve the best results, test on the skin sample first.

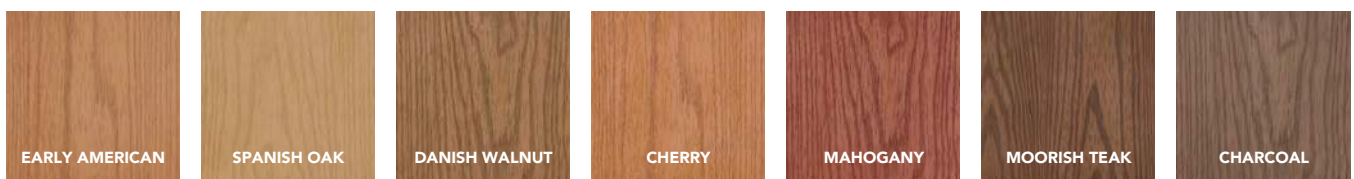

Colors shown have one coat of stain.

MATERIALS NEEDED

PLASTPRO'S PRE-FINISH KIT OR:

- | | |
|---------------------------------|---------------------------|
| A. Pre-Mixed Stain (1/2 pint) | F. 3" China Bristle Brush |
| B. Mineral Spirits (4 fl. oz.) | G. Two Stir Sticks |
| C. Top Coat/Sealer (20 fl. oz.) | H. Two Skin Samples |
| D. Two Clean Cloth | I. Finishing Instruction |
| E. One Pair Protective Gloves | |

STAINING INSTRUCTIONS FOR GRAINED DOORS & PFT™ DOOR FRAMES



STEP 1: SURFACE PREPARATION

1. Lay door horizontally on saw horses or a table.
2. Remove all the hardware and mask off anything you don't want stained such as the glass insert.
3. DO NOT SAND GRAINED FIBERGLASS / PFT™ DOOR FRAMES
4. Wipe the Door / PFT™ Door Frame with mineral spirits to clean any dust or residue from the surface. Allow door surface to dry completely before applying stain.



STEP 2: STAIN APPLICATION

1. Starting at the center of the Door / PFT™ Door Frame, stain one to two panels at a time. Apply stain with a 3" to 4" soft bristle brush, or rag. Apply enough stain to fill the Door / PFT™ Door Frame grain.
2. With a clean, lint free 24" x 24" cloth, softly wipe the surface until you reach your desired tone. TIP: When the rag becomes saturated with stain, refold to work with a less saturated section. Be sure to use the same rag for the whole Door / PFT™ Door Frame.
3. After all stain is brushed evenly, you may add finishing touches by using a small 1" to 2" brush or cotton swabs.
4. (If desired) Allow the Door / PFT™ Door Frame to dry for at least 48 hours before applying another coat. Then, repeat above process.



STEP 3: PROTECTIVE TOP COAT

Application of polyurethane top coat with UV inhibitors like ZAR™ Exterior polyurethane, Wood Kote® Flagship UV, or Minwax® Fast Drying Polyurethane for exterior applications.

1. After stain has completely dried (48 hours), mix the top coat well and apply evenly using a clean dry 2" soft bristle brush or 3" foam brush. Be sure to stop when the grain changes direction.
2. Apply two or three coats of finish, allowing at least 24 hours of drying time between each application.

IMPORTANT TO NOTE:

- It is considered normal maintenance to re-apply the topcoat approximately every two years. Even a well-finished fiberglass door will be affected by exposure and weathering from sun, moisture, and air pollutants.
- Staining instructions are for Oil-Based, Premium Quality Wood Stains or similar product designed for use on a fiberglass surface. Please note the instructions indicated are specific to the Zar brand stain included in our stain kit. Please reference stain manufacturers instructions before applying any stain.

MATERIALS NEEDED

- | | |
|--------------------|--|
| A. Lint-free cloth | E. 4" Bristle Brush |
| B. Mineral Spirits | F. For Water-based Application: Acrylic-based primer*/ acrylic latex-based exterior grade paint. |
| C. Rubber gloves | |
| D. Masking tape | |

We recommend using Sherwin-Williams PrepRite® Bonding Primer with compatible acrylic-latex paint for optimal paint adhesion.

PAINTING INSTRUCTIONS FOR OAK GRAIN DOORS



STEP 1: SURFACE PREPARATION

1. Lay door horizontally on saw horses or a table.
2. Remove all the hardware and mask off anything you don't want painted, such as the glass insert.
3. DO NOT SAND GRAINED FIBERGLASS.
4. Wipe the door with mineral spirits to clean any dust or residue from the surface. Allow door surface to dry completely before applying stain paint. Do not use hydro-carbon based solvents to clean the surface as such products may leave a residue.
5. Apply primer with a 4" brush beginning with the panels. Follow the manufacturer's instructions for drying time before applying topcoat. Continue to apply the primer to ALL 6 sides. Doors which have been bored and mortised for hardware should be primed inside of the lock bore as well.
6. The primer must be completely dry before applying the topcoat.



STEP 2: PAINTING

1. Apply exterior grade paint with 4" brush beginning with the panels.
2. It is common practice to paint both stiles the same color as the exterior side of the door. If applying a second coat, follow the manufacturer's instructions for drying time between coats.
3. Continue to apply the top coat to ALL 6 sides of the door which have been bored and mortised for hardware should be finished inside of the lock bore as well.

CAUTION

1. When using stains, mineral spirits, paints, or other hazardous materials, always read and follow the manufacturer's instructions. Plastpro, Inc. makes no representations as to the proper use of other manufacturers' products.
2. When working with paints or solvents, make sure the working area is well ventilated.
3. Keep away from heat and flame as materials may be combustible.
4. Paints or solvents may cause skin and eye irritation. Avoid contact with skin and eyes.
5. Keep out of reach of children.

IMPORTANT TO NOTE:

- It is considered normal maintenance to re-apply the topcoat approximately every two years. Even a well-finished fiberglass door will be affected by exposure and weathering from sun, moisture, and air pollutants.

MATERIALS NEEDED

- A. Lint-free Cloth
- B. Mineral Spirits
- C. Rubber Gloves
- D. Masking Tape
- E. 4" Bristle Brush

F. For Water-based Application: Acrylic-based primer* / acrylic latex-based exterior grade paint.

G. Scotch Brite Pad (Fine) or 320-400 grit sandpaper
(For Smooth Doors Only)

We recommend using Sherwin-Williams PrepRite® Bonding Primer with compatible acrylic-latex paint for optimal paint adhesion.

PAINTING INSTRUCTIONS FOR DOORS & PF™ DOOR FRAMES



STEP 1: SURFACE PREPARATION

1. Lay door horizontally on saw horses or a table.
2. Remove all the hardware and mask off anything you don't want painted, such as the glass insert.
3. **Smooth Doors only.** Lightly scuff sand the surface with a Scotch Brite pad or fine sand paper. **DO NOT SAND GRAINED FIBERGLASS.**
4. Wipe the door with mineral spirits to clean any dust or residue from the surface. Allow acetone to dry from the surface before applying.
5. Do not use hydro-carbon based solvents to clean the surface as such products may leave a residue.
6. Apply primer with a 4" brush beginning with the panels. Follow the manufacturer's instructions for drying time before applying topcoat. Continue to apply the prime to ALL 6 sides. Doors / PF™ Door Frames which have been bored and mortised, or machined for hardware should be primed inside of the lock bore, or prepped area as well.
7. The primer must be completely dry before applying the topcoat.



STEP 2: PAINTING

1. Apply exterior grade paint with 4" brush beginning with the panels.
2. It is a common practice to paint both door stiles, or both PF™ Door Frame sides, the same color as the exterior side of the door. If applying a second coat, follow the manufacturer's instructions for drying time between coats.
3. Continue to apply the top coat to ALL 6 sides of the door which have been bored and mortised for hardware should be finished inside of the lock bore as well.

CAUTION

1. When using stains, mineral spirits, paints, or other hazardous materials, always read and follow the manufacturer's instructions. Plastpro Inc. makes no representations as to the proper use of other manufacturers' products.
2. When working with paints or solvents, make sure the working area is well ventilated.
3. Keep away from heat and flame as materials may be combustible.
4. Paints or solvents may cause skin and eye irritation. Avoid contact with skin and eyes.
5. Keep out of reach of children.

IMPORTANT TO NOTE:

- It is considered normal maintenance to re-apply the topcoat approximately every two years. Even a well-finished fiberglass door will be affected by exposure and weathering from sun, moisture, and air pollutants.



Nova Series Door • DRS1SB



PLASTPRO DOORS & THEIR LEED CONTRIBUTIONS

		RUSTIC	OAK	SMOOTH	TRIMMABLE	FIRE RATED	HVHZ	PFTM [™] DOOR FRAMES	TRIM BOARD
10%	Contributes To Total Project Value of Recycled Content	✓	✓	✓	✓	✓	✓	✓	
20%	Contributes To Total Project Value of Recycled Content	✓	✓	✓	✓	✓	✓	✓	
10%	Contributes To Total Project Value of Regional Materials	✓	✓	✓	✓	✓	✓	✓	
20%	Contributes To Total Project Value of Regional Materials	✓	✓	✓	✓	✓	✓	✓	
2.5%	Contributes To Total Project Value of Regional Materials	✓	✓	✓	✓	✓	✓	✓	

All Plastpro products that utilize structural wood members are sourced from vendors certified to SFI (Sustainable Forest Initiative), Plastpro does not offer products that are certified by FSC (Forest Stewardship Council)

	MATERIAL RESOURCE	REQUIREMENT
10%	RECYCLE CONTENT	The sum of post consumer recycle content plus one-half of pre-consumer content constitutes at least 10% of cost, for the total value of the materials for that project.
20%	RECYCLE CONTENT	The sum of post consumer recycle content plus one-half of pre-consumer content constitutes at least 20% of cost, for the total value of the materials for that project.
10%	REGIONAL MATERIALS	Use of building materials or products extracted, harvested, or recovered as well as manufactured, with-in 500 mi. of the project site (= > 10% total project material cost)
20%	REGIONAL MATERIALS	20% Use of building materials or products extracted, harvested, or recovered as well as manufactured, with-in 500 mi. of the project site (= > 20% total project material cost)
2.5%	RAPIDLY RENEWABLE MATERIAL	Use of building materials or products made from plants, typically harvested, with-in a ten-year cycle or shorter (= > 2.5% total project material cost)



PRODUCT INDEX

Easily locate Plastpro Doors, PF™ Door Frames and accessories within the catalog.

PG 188 - 193

PFT™ DOOR FRAMES

CATEGORY	NAME	AVAILABLE GRAINS	PAGE
DOOR FRAME	4-9/16" Door Frame	Oak Grain, Fir Grain, Mahogany, Primed, White Capped	9
	5-1/4" Door Frame	Primed, White Capped	9
	6-9/16" Door Frame	Oak Grain, Fir Grain, Mahogany, Primed, White Capped	9
	7-1/4" Door Frame	Primed, White Capped	9
	WM180 Florida Brickmold	Oak Grain, Fir Grain, Mahogany, Primed, White Capped	9
	WM176 Brickmold	Oak Grain, Primed	9
	1-1/2" x 1" Mull Post Cover	Oak Grain, Fir Grain, Mahogany, Primed, White Capped	9
	2" x 1" Mull Post Cover	Oak Grain, Fir Grain, Mahogany, Primed, White Capped	9
	Mull Post Cap	Oak Grain, PVC - White	9
	Mull Post w/ LVL-3P	Oak Grain, Fir Grain, Mahogany, Primed, White Capped	9
	1" x 2" Stuccomold	Primed	9
	4.528" x 17' Primed Backband	Primed	9
	3.21" x 6'8" Astragal	PVC - White	9
	3.21" x 8'0" Astragal	PVC - White	9
	.551" x 8'4" Sidelite Stopper	Oak Grain, Primed	9
	Nailing Fin	Oak Grain, Primed, White Capped	9
	J-Channel	Oak Grain, Primed, White Capped	9
	Flat casing	Oak Grain, Primed, White Capped	9
	Flat Casing J-Channel	Oak Grain, Primed, White Capped	9
	Trim Boards	PVC - White	9
	1-1/4" x 3" Jamb Extension	Oak Grain, Fir Grain, Mahogany, Primed, White Capped	9
	1" x 2-1/2" Storm Door Extension	Oak Grain, Fir Grain, Mahogany, Primed, White Capped	9
	1" x 3" Storm Door Extension	Oak Grain, Fir Grain, Mahogany, Primed, White Capped	9
	4-9/16" Transom Sill	Oak Grain, Fir Grain, Mahogany, Primed, White Capped	9
	6-9/16" Transom Sill	Oak Grain, Fir Grain, Mahogany, Primed, White Capped	9
	PFT™ Arch & Radius Headers	Oak Grain	9

FIBERGLASS ENTRY SYSTEMS

SERIES	CODE	HEIGHT	WIDTH	DESCRIPTION	PAGE
LIMITED	DRC21	6'8"	3'0"	Two Panel	32 - 33
	DMT51	6'8"	2'8", 2'10", 3'0", 3'6"	Modern Teak Milan Door	34
	DMT5170	7'0"	3'0", 3'6"	Modern Teak Milan Door	34
	DRK2B	6'8"	2'8", 2'10", 3'0"	Two Panel	35
MODERN	DMG46	6'8"	2'6", 2'8", 2'10", 3'0", 3'6"	South Beach, Oak Grain	38
	DMG4680	8'0"	2'6", 2'8", 2'10", 3'0", 3'6"	South Beach, Oak Grain	38
	DMG51	6'8"	2'6", 2'8", 2'10", 3'0"	Napoli, Oak Grain	38
	DMG5180	8'0"	2'6", 2'8", 2'10", 3'0"	Napoli, Oak Grain	38
	DMS1L	6'8"	2'6", 2'8", 2'10", 3'0", 3'6"	Bienvenue Left Lite, Smooth Skin	39
	DMS1L80	8'0"	3'0", 3'6"	Bienvenue Left Lite, Smooth Skin	39
	DMS1R	6'8"	2'6", 2'8", 2'10", 3'0", 3'6"	Bienvenue Right Lite, Smooth Skin	40
	DMS1R80	8'0"	3'0", 3'6"	Bienvenue Right Lite, Smooth Skin	40
DMS1T	6'8"	2'6", 2'8", 2'10", 3'0", 3'6"	Martinique Twin Lite, Smooth Skin	41	

SERIES	CODE	HEIGHT	WIDTH	DESCRIPTION	PAGE
MODERN	DMS1T80	8'0"	3'0", 3'6"	Martinique Twin Lite, Smooth Skin	41
	DMS3HI	6'8"	2'6", 2'8", 2'10", 3'0"	Empire, Smooth Skin	42
	DMS3H80I	8'0"	2'6", 2'8", 2'10", 3'0"	Empire, Smooth Skin	42
	DMS5HI	6'8"	2'6", 2'8", 2'10", 3'0"	Infinity, Smooth Skin	42
	DMS5H80I	8'0"	2'6", 2'8", 2'10", 3'0"	Infinity, Smooth Skin	42
RUSTIC	DRATP	6'8"	2'6", 3'0", 3'6"	True Plank, Square Top	46
	DRATP70	7'0"	3'0"	True Plank, Square Top	46
	DRATP80	8'0"	2'6", 3'0", 3'6"	True Plank, Square Top	46
	DRA1A80	8'0"	3'0", 3'6"	One Panel, Arch Plank	46
	DRA1P	6'8"	3'0"	One Panel, Square Plank	47
	DRA1P80	8'0"	3'0", 3'6"	One Panel, Square Plank	47
	DRA2A	6'8"	3'0"	Two Panel, Arch Plank	48
	DRA2A80	8'0"	3'0", 3'6"	Two Panel, Arch Plank	48
	DRA2B	6'8"	3'0"	Two Panel, Square Panel	49
	DRA2C	6'8"	3'0"	Two Panel, Arch Plank, Arch Top	50
	DRA2C80	8'0"	3'0", 3'6"	Two Panel, Arch Plank, Arch Top	50
	DRA2D	6'8"	3'0", 3'6"	Two Panel, Arch Panel	51
	DRA2F80	8'0"	3'0"	Two Panel, Radius Panel, Radius Top	52
	DRA2P80	8'0"	3'0", 3'6"	Two Panel, Square Plank	52
	DRA2R80	8'0"	3'0"	Two Panel, Radius Panel	53
	DRA4R80	8'0"	3'0", 3'6"	Four Panel, Radius Panel	53
	ACCLP12Q	1 1/2"	1 1/2"	Square Clavos	54
	ACCLP14Q	1 1/4"	1 1/4"	Square Clavos	54
	ACCLP12R	1 1/2"	1 1/2"	Round Clavos	54
	ACCLP14R	1 1/4"	1 1/4"	Round Clavos	54
	ACCHGSTP18	2 1/9"	18"	Wrought Iron Hinge Strap	55
	ACCSPKY0910KIT	15 1/4"	8 3/4"	Wrought Iron Speakeasy	55
	ACCSPKYGSB0KIT	11 8/9"	9 8/9"	Wrought Iron Speakeasy	55
MAHOGANY	DRM3D	6'8"	3'0"	Three Panel Deluxe	58
	DRM4E	6'8"	3'0"	Four Panel Eyebrow	59
	DRM40	6'8"	2'6", 2'8", 2'10", 3'0"	Four Panel Blank Top	60 - 61
	DRM41	6'8"	3'6"	True Four Panel	63
	DRM60	6'8"	3'0"	Six Panel	64
	DRM6080	8'0"	3'6"	Six Panel	64
FIR GRAIN	DRF3C	6'8"	3'0"	Direct Glazed Craftsman	68
	DRF3C80	8'0"	3'0"	Direct Glazed Craftsman	69 - 69
	DRF1K	6'8"	2'8", 2'10", 3'0"	One Panel Square Top Shaker	70
	DRF2K	6'8"	2'8", 2'10", 3'0"	Two Panel Square Top Shaker	70
	DRF3F	6'8"	2'8", 2'10", 3'0"	Three Panel Shaker Craftsman	71
	DRF3F80	8'0"	3'0"	Three Panel Shaker Craftsman	71
	DRF50	6'8"	2'8", 2'10", 3'0"	Five Panel Shaker Craftsman	71
	ACDSFT2704	3 5/8"	27"	4 Block Dentil Shelf	73
	ACSDF23001	1 1/2"	17 1/8" (4 pcs)	3-Lite SDL Bars for 6'8" Door	73
	ACSDF23005	1 1/2"	23" (4 pcs)	3-Lite SDL Bars for 8'0" Door	73
	ACSDF23002	1 1/2"	25 3/4" (2 pcs), 8 21/32" (8 pcs)	6-Lite SDL Bars for 6'8" Door	73

SERIES	CODE	HEIGHT	WIDTH	DESCRIPTION	PAGE	
FIR GRAIN	ACSDF23006	1 1/2"	26" (2 pcs), 11 3/16" (8 pcs)	6-Lite SDL Bars for 8'0" Door	73	
	ACSDF23004	1 1/2"	8 3/4" (2 pcs)	2-Lite SDL Bars for 6'8" and 8'0" Sidelite	73	
OAK GRAIN	DRG00	6'8"	2'0", 2'4" 2'6", 2'8", 2'10", 3'0", 3'6"	Flush	76 - 78	
	DRG0070	7'0"	2'0", 2'4" 2'6", 2'8", 2'10", 3'0", 3'6"	Flush	76 - 78	
	DRG0080	8'0"	2'0", 2'4" 2'6", 2'8", 2'10", 3'0", 3'6"	Flush	76 - 78	
	DRG20	6'8"	3'0"	3/4 Heritage	80	
	DRG29	6'8"	2'8", 2'10", 3'0"	3/4 Two Panel	81 - 82	
	DRG2980	8'0"	2'8", 2'10", 3'0"	3/4 Two Panel	81 - 82	
	DRG3E	6'8"	3'0"	3/4 Elite	84	
	DRG3P	6'8"	3'0"	3/4 Premium	85	
	DRG3080	8'0"	2'8", 3'0", 3'6"	3/4 Three Panel	86 - 87	
	DRG31	6'8"	3'0"	Three Panel	88	
	DRG3170	7'0"	3'0"	Three Panel	88	
	DRG40	6'8"	2'6", 2'8", 2'10", 3'0"	Four Panel Blank Top	89 - 90	
	DRG41	6'8"	2'8", 2'10", 3'0", 3'6"	True Four Panel	92 - 93	
	DRG4170	7'0"	2'8", 2'10", 3'0"	True Four Panel	92 - 93	
	DRG4180	8'0"	2'8", 2'10", 3'0"	True Four Panel	92 - 93	
	DRG49	6'8"	2'8", 2'10", 3'0"	3/4 Four Panel	95	
	DRG6C	6'8"	3'0"	Six Panel Craftsman	97	
	DRG60	6'8"	2'6", 3'0"	Six Panel	98	
	DRG6080	8'0"	2'6", 2'8", 3'0", 3'6"	Six Panel	98	
	DRG61	6'8"	2'8", 2'10", 3'0"	Six Panel Utility	99 - 100	
	DRG6170	7'0"	2'8", 2'10", 3'0"	Six Panel Utility	99 - 100	
	DRG6180	8'0"	2'8", 2'10", 3'0"	Six Panel Utility	99 - 100	
	DRG6B	6'8"	2'8", 2'10", 3'0"	Six Panel w/ 10" Bottom Rail	99 - 100	
	DRG63	6'8"	2'8", 2'10", 3'0"	True Six Panel Narrow	102	
	DRG80	6'8"	3'0"	Eight Panel, Center Arch	104	
	DRG8080	8'0"	3'0", 3'6"	Eight Panel, Center Arch	104	
	DRG90	6'8"	2'8", 3'0"	Nine Panel	105	
	DRG9180	8'0"	3'0"	Nine Panel	106	
	ACDSGT2704	3"	27"	4 Block Dentil Shelf	107	
	ACDSGT2716	3 2/3"	27 1/9"	16 Block Dentil Shelf	107	
	SMOOTH	DRS00	6'8"	2'0", 2'4" 2'6", 2'8", 2'10", 3'0", 3'6"	Flush	112 - 114
		DRS0070	7'0"	2'0", 2'4" 2'6", 2'8", 2'10", 3'0", 3'6"	Flush	112 - 114
DRS0080		8'0"	2'0", 2'4" 2'6", 2'8", 2'10", 3'0", 3'6"	Flush	112 - 114	
DRS2B		6'8"	2'8", 2'10", 3'0"	Two Panel	115 - 116	
DRS2B80		8'0"	2'8", 2'10", 3'0"	Two Panel	115 - 116	
DRS2D		6'8"	2'8", 2'10", 3'0"	Two Panel, Arch Panel	118 - 119	
DRS2D80		8'0"	2'8", 2'10", 3'0"	Two Panel, Arch Panel	118 - 119	
DRS2G		6'8"	2'8", 2'10", 3'0"	Cottage Two Panel	120	
DRS2G80		8'0"	2'8", 2'10", 3'0"	Cottage Two Panel	120 - 121	
DRS20		6'8"	3'0"	3/4 Heritage	122	
DRS29		6'8"	2'8", 2'10", 3'0"	3/4 Two Panel	123	
DRS2980		8'0"	2'8", 2'10", 3'0"	3/4 Two Panel	123 - 124	
DRS3C		6'8"	3'0"	Direct Glazed Craftsman	126	

SERIES	CODE	HEIGHT	WIDTH	DESCRIPTION	PAGE	
SMOOTH	DRS3C80	8'0"	3'0"	Direct Glazed Craftsman	126	
	DRS3E	6'8"	3'0"	3/4 Elite	127	
	DRS3P	6'8"	3'0"	3/4 Premium	129	
	DRS3080	8'0"	2'8", 3'0", 3'6"	3/4 Three Panel	130 - 131	
	DRS31	6'8"	3'0"	Three Panel	132	
	DRS3170	7'0"	3'0"	Three Panel	132	
	DRS40	6'8"	2'6", 2'8", 2'10", 3'0"	Four Panel Blank Top	133 - 134	
	DRS41	6'8"	2'8", 2'10", 3'0"	True Four Panel	135	
	DRS4170	7'0"	2'8", 2'10", 3'0"	True Four Panel	135 - 136	
	DRS4180	8'0"	2'8", 2'10", 3'0"	True Four Panel	135 - 136	
	DRS42	6'8"	2'6"	Four Panel Blank Top	133	
	DRS49	6'8"	2'8", 2'10", 3'0"	3/4 Four Panel	138	
	DRS6C	6'8"	3'0"	Six Panel Craftsman	140	
	DRS60	6'8"	2'6", 3'0"	Six Panel	141	
	DRS6080	8'0"	2'6", 2'8", 3'0"	Six Panel	141	
	DRS6B	6'8"	2'8", 2'10", 3'0"	Six Panel w/ 10" Bottom Rail	142	
	DRS61	6'8"	2'8", 2'10", 3'0"	Six Panel Utility	142	
	DRS6170	7'0"	2'8", 2'10", 3'0"	Six Panel Utility	142 - 143	
	DRS6180	8'0"	2'8", 2'10", 3'0"	Six Panel Utility	143	
	DRS63	6'8"	2'8", 2'10", 3'0"	True Six Panel Narrow	145	
	DRS80	6'8"	3'0"	Eight Panel, Center Arch	147	
	DRS8080	8'0"	3'0", 3'6"	Eight Panel, Center Arch	147	
	DRS90	6'8"	2'8", 3'0"	Nine Panel	148	
	DRS1K	6'8"	2'8", 2'10", 3'0"	One Panel Square Top Shaker	149	
	DRS2K	6'8"	2'8", 2'10", 3'0"	Two Panel Square Top Shaker	149	
	DRS3F	6'8"	2'8", 2'10", 3'0"	Three Panel Shaker Craftsman	150	
	DRS3F80	8'0"	3'0"	Three Panel Shaker Craftsman	150	
	DRS50	6'8"	2'8", 2'10", 3'0"	Five Panel Shaker Craftsman	150	
	ACSDW23005			17 1/8" (4 pcs)	3-Lite SDL Bars for 6'8" Door	152
	ACSDW23001			23" (4 pcs)	3-Lite SDL Bars for 8'0" Door	152
	ACSDW23006			25 3/4" (2 pcs), 8 21/32" (8 pcs)	6-Lite SDL Bars for 6'8" Door	152
	ACSDW23002			26" (2 pcs), 11 3/16" (8 pcs)	6-Lite SDL Bars for 8'0" Door	152
	ACSDW23004			8 3/4" (2 pcs)	2-Lite SDL Bars for 6'8" and 8'0" Sidelite	152
	ACDSSW2404			24"	4 Block Dentil Shelf	152 - 153
	ACDSSW2704			27"	4 Block Dentil Shelf	152 - 153
	ACDSSW2716			27 1/9"	16 Block Dentil Shelf	152 - 153
TRUE WHITE OAK	DRW00	6'8"	2'0", 2'4" 2'6", 2'8", 2'10", 3'0"	Flush	156 - 157	
	DRW0070	7'0"	2'0", 2'4" 2'6", 2'8", 2'10", 3'0"	Flush	156 - 157	
	DRW0080	8'0"	2'0", 2'4" 2'6", 2'8", 2'10", 3'0"	Flush	156 - 158	
	DRW40	6'8"	2'6", 2'8", 2'10", 3'0"	Four Panel Blank Top	159 - 160	
	DRW41	6'8"	2'8", 2'10", 3'0"	True Four Panel	162	
	DRW60	6'8"	2'6", 3'0"	Six Panel	164	
	DRW6080	8'0"	2'6", 3'0"	Six Panel	164	
	DRW61	6'8"	2'6", 2'8", 2'10", 3'0"	Six Panel Utility	165	

SERIES	CODE	HEIGHT	WIDTH	DESCRIPTION	PAGE
TRUE WHITE OAK	DRW6170	7'0"	2'8", 2'10", 3'0"	Six Panel Utility	165 -166
	DRW63	6'8"	2'8", 2'10", 3'0"	True Six Panel Narrow	168
ONELITE SERIES	DRS11	6'8"	3'0"	Full Lite - Commercial ADA	172
	DRS1170	7'0"	3'0"	Full Lite	172
	DRS1180	8'0"	3'0"	Full Lite	172
	DRG12	6'8"	2'8", 3'0"	Flush Glazed Half Lite	173
	DRG12 G09	6'8"	2'8", 3'0"	9 Lite GBG	173
	DRG12B	6'8"	2'8", 3'0"	Half Lite with Miniblinds	173
	DRS12	6'8"	2'8", 3'0"	Flush Glazed Half Lite	174
	DRS12 G09	6'8"	2'8", 3'0"	9 Lite GBG	174
	DRS12B	6'8"	2'8", 3'0"	Half Lite with Miniblinds	174
	DRS13	6'8"	2'6", 2'8", 3'0"	Flush Glazed 3/4 Lite	175
	DRS1380	8'0"	2'6", 2'8", 3'0"	Flush Glazed 3/4 Lite	175
	DRM13	6'8"	2'6", 2'8", 3'0"	Flush Glazed 3/4 Lite	176
	DRM1380	8'0"	2'6", 2'8", 3'0"	Flush Glazed 3/4 Lite	176
	ACSDM/S1368L08C	1 1/4"	48 5/32" (2 pcs), 12 59/64" (12 pcs)	8-Lite SDL Bars for 6'8" Door	177
	ACSDM/S1380L10C	1 1/4"	64 5/32" (2 pcs), 12 59/64" (16 pcs)	10-Lite SDL Bars for 8'0" Door	177
NOVA SERIES	DRS1DL	6'8"	2'0", 2'6", 2'8", 3'0"	Smooth Direct Glazed Full Lite w/ LowE	180
	DRS1D80L	8'0"	2'0", 2'6", 2'8", 3'0"	Smooth Direct Glazed Full Lite w/ LowE	180
	DRF1DL	6'8"	2'0", 2'6", 2'8", 3'0"	Fir Direct Glazed Full Lite w/ LowE	180
	DRF1D80L	8'0"	2'0", 2'6", 2'8", 3'0"	Fir Direct Glazed Full Lite w/ LowE	180
	DRS1S	6'8"	2'0", 2'6", 2'8", 2'10", 3'0"	Brushed Direct Glazed Full Lite w/Miniblind	181
	DRS1S80	8'0"	2'0", 2'6", 2'8", 2'10", 3'0"	Brushed Direct Glazed Full Lite w/Miniblind	181

THE DOOR OF BEAUTY AND INNOVATION

